



LEADING SWISS PRODUCTS



ProofMaster[®]

Operating instructions

Characteristic data

Document

Type: Operating instructions

Language: English

Change log

Version	Date	Author	Description
Version 1.0	18.10.2019	RdT – BRY	First edition.
Version 1.1	21.04.2020	RdT – BRY	Start by pressing the bell cover and user management.
Version 1.2	10.06.2020	RdT – BRY	New calibration sticker.
Version 1.3	15.02.2021	RdT – MAG	Administration of the two software versions and addition to the use of the ChronoMaster.

Info



The original text of these instructions is written in German.

Translations are made for information purposes only. In cases of doubt, only the German version shall be decisive.

Manufacturer

Witschi Electronic AG

Bahnhofstrasse 26

3294 Büren an der Aare

Switzerland

Product

ProofMaster

Copyright

Reproduction of this document in whole or in part is not permitted.

Without the prior written consent of Witschi Electronic AG, no section may be copied, edited or electronically reproduced, transmitted or recorded on magnetic media or in any other way.

All rights, in particular those of reproduction, distribution and translation into other languages, as well as those of patent law and patent application are reserved. The same copyright also applies to the software supplied with the devices from Witschi Electronic AG.

© Copyright Witschi Electronic AG, 2021 – all rights reserved.

Table of contents

1	General information.....	6
1.1	Technical support.....	7
1.2	Definitions.....	7
1.3	Versions.....	8
1.4	Guarantee.....	8
2	Safety.....	9
2.1	General pictograms.....	9
2.2	Proper use.....	10
2.3	Safety sign.....	11
2.3.1	Labels on the device.....	11
2.3.2	Labels on the power supply unit.....	11
2.4	Residual risks.....	11
2.5	Owner's liability.....	15
2.6	Personnel qualifications.....	16
2.7	Personal protective equipment.....	17
2.8	Spare parts.....	17
2.9	Noise emissions.....	17
3	Initial operation.....	18
3.1	Moving the device.....	18
3.2	Transport inspection.....	19
3.3	Storage conditions.....	19
3.4	Space requirement.....	20
3.5	Requirements regarding the installation site.....	20
3.6	Working area of the operator.....	21
3.7	List of equipment.....	22
3.8	Initial operation.....	23
3.8.1	Current.....	23
3.8.2	Compressed air.....	24
3.8.3	Thermal printer.....	25
3.8.4	Network.....	26
4	Description.....	27
4.1	Proofmaster.....	27
4.2	Included accessories.....	28
4.3	Required accessories.....	30

4.4	Optional accessories	31
4.5	Procedure of a tightness test	32
4.6	Definitions	33
4.7	Reference to standard ISO 22810	34
5	Use	35
5.1	Safety during use	35
5.2	Basic operation	36
5.2.1	Switching on the Proofmaster	36
5.2.2	Enabling screen saver or standby	37
5.2.3	Switching off the device	38
5.2.4	Determining test pressure values	38
5.2.5	Programming a quick test	40
5.2.6	Selecting the program	42
5.2.7	Starting the test	43
5.2.8	Cancelling the test	44
5.2.9	Positioning the watch	44
5.2.10	Manually lowering/lifting the sensor	45
5.2.11	Identifying the tests	46
5.3	Measurement results	47
5.3.1	Displaying test results	47
5.3.2	Selecting the results display	49
5.3.3	Access to results (ProofMaster PRO)	50
5.3.4	Sorting results (ProofMaster PRO)	51
5.3.5	Deleting measurement results (ProofMaster PRO)	52
5.4	LeakFinder (ProofMaster PRO)	53
5.5	Programming	57
5.5.1	Menus and operating buttons	57
5.5.2	Preset programs	58
5.5.3	Creating a program (ProofMaster PRO)	59
5.5.4	Editing a program (ProofMaster PRO)	61
5.5.5	Deleting a program (ProofMaster PRO)	62
5.5.6	Viewing a program	63
5.6	ChronoMaster	64
5.6.1	Connecting the ChronoMaster	64
5.6.2	Starting the measurement	64
5.6.3	Configuring the measurement	65
6	Maintenance	67
6.1	Safety during maintenance	67
6.2	Maintenance schedule	68
6.3	Cleaning the seal (O ring)	69
6.4	Replacing the seal (O ring)	69
6.5	Replacing the deformation sensor	69

6.6	Software updates	70
6.7	Accessories and spare parts.....	71
7	Settings	72
7.1	Quick settings menu.....	72
7.2	Settings.....	73
7.3	System	74
7.3.1	Language selection.....	74
7.3.2	Screen saver.....	75
7.3.3	Display and audio settings	76
7.3.4	Date & time.....	77
7.4	Device.....	79
7.4.1	Opening speed of the bell cover.....	79
7.4.2	Start by pressing the bell cover.....	79
7.4.3	Sensor lighting.....	80
7.4.4	Quiet pressure release.....	80
7.4.5	Unit of leak rate.....	81
7.5	User management (ProofMaster PRO)	82
7.5.1	Administrator and user modes.....	82
7.5.2	Activating user mode.....	83
7.5.3	Activating administrator mode.....	83
7.5.4	Changing the password.....	84
7.6	Import/export.....	85
7.6.1	Importing/exporting settings.....	85
7.6.2	Importing/exporting programs (ProofMaster PRO).....	87
7.6.3	Exporting measurements.....	89
7.6.4	Resetting the device settings	90
7.6.5	Restoring factory settings	91
7.7	Printer.....	92
7.7.1	Configuring the printer	92
7.7.2	Configuring the label.....	93
7.8	Network.....	96
7.9	WiCoTRACE.....	97
7.10	System information	98
8	Troubleshooting.....	99
8.1	Error messages	99
8.2	Malfuctions.....	100
8.3	Opening the bell cover in an emergency.....	101
9	Decommissioning and disposal.....	102
10	Data sheet.....	103

1 General information

Purpose of the documentation

This documentation contains the necessary information for the proper operation of the device.

This allows the user to perform operating or maintenance procedures efficiently.

For reasons of safety and environmental protection, the service instructions must be followed. In any case, the documentation should be consulted.

Liability

Witschi Electronic AG assumes no liability for errors or omissions.

Conformity with standards and guidelines

The "CE" marking confirms that this product complies with the European requirements regarding safety, health, environmental and user protection.



See also the declaration of conformity supplied with the machine.

Proper use

The instructions in this document must be observed, in particular the safety precautions.

General information

This document has been prepared on the basis of the information available at the time of its publication.

These instructions enable safe and efficient handling of the ProofMaster leak tightness testing device (referred to in the following as "device" or "ProofMaster"). These instructions are an integral part of the device and must be kept near the device so that it can be accessed by personnel at all times.

Personnel must have carefully read through and understood these instructions before starting work. To ensure safe working, the safety indications, warnings and instructions must be followed.

In addition, the local health and safety regulations as well as the general safety rules for operation of the ProofMaster must be observed.

Illustrations contained in these instructions are intended for illustration purposes only and may deviate from the model sold.

1.1 Technical support

Rating plate



The rating plate of the ProofMaster is located on the reverse of the device and contains the following information:

- Manufacturer
- Device name
- Type
- Serial number
- Year of manufacture

Technical support inquiries

To request technical support from Witschi Electronic AG, proceed as follows:

- a) Observe the specifications on the machine's rating plate.
- b) Try to clearly identify the error that occurred.
- c) Contact the customer service of Witschi Electronic AG.

Customer service

The point of sale can provide you with technical information.

The nearest point of sale can be found on the Witschi Electronic AG website www.witschi.com.

Witschi Electronic AG would also be pleased to receive information and feedback, which can be helpful for the improvement of the products.

Information on customer service

Address: Witschi Electronic AG
 Bahnhofstrasse 26
 3294 Büren an der Aare
 Switzerland

Telephone: +41 32 352 05 00

Fax: +41 32 351 32 92

Internet: www.witschi.com

E-mail: service@witschi.com

1.2 Definitions

User

The user is the owner of a device which he or she uses as the owner or which he or she gives to third parties for use.

Operator

The operator is the person who carries out production or operating processes with the device.

Technical personnel

Technical personnel are defined as all persons whose training and qualifications entitle them to carry out installation and maintenance work on the device. Any work on the electrical and mechanical components of the device must be carried out by Witschi Electronic AG.

Device

A device is defined as the entirety of the ProofMaster.

1.3 Versions

There are two potential software versions for the ProofMaster:

- ProofMaster and
- ProofMaster PRO.

The ProofMaster PRO software version has the widest range of functions.

All functions are described in the operating instructions. Differences between the two software versions are indicated by (ProofMaster PRO).

Info



The token is created precisely for the device to be expanded. The token contains the item number and the serial number of the device. An upgrade to PRO can be purchased at any time.

1.4 Guarantee

Witschi Electronic AG grants two years warranty on the new ProofMaster. Further information can be found in the **Warranty information document** supplied with the ProofMaster.

2 Safety

This section provides an overview of all the important safety aspects that ensure personal protection and safe and trouble-free operation. The relevant sections contain additional warnings on the various tasks.

Mandatory



All safety and protection regulations described here must be read and observed in order to avoid damage to equipment, persons and the environment.

The legal regulations, accident prevention and environmental protection measures as well as the relevant technical regulations for safe working methods in the country of use and at the place of installation of the device must also be observed.

2.1 General pictograms

DANGER



This combination of symbol and keyword indicates an imminently hazardous situation that will result in serious or fatal injury if not avoided.

WARNING



This combination of symbol and keyword indicates a potentially hazardous situation that can result in serious or fatal injury if not avoided.

CAUTION



This combination of symbol and keyword indicates a potentially hazardous situation that can result in minimal or minor injury if not avoided.

Caution - material



This combination of symbol and keyword indicates a potentially hazardous situation that can entail material damage if not avoided.

Caution - environmental



This combination of symbol and keyword indicates a potentially hazardous situation that can entail environmental damage if not avoided.

Prohibition



Mandatory advice to follow.

Mandatory



Applicable guideline, measure.

Info



Informative comment.

Tip



Recommendation or advice.

2.2 Proper use

The "ProofMaster" leak tightness testing device is used exclusively for testing the water resistance of watches by means of positive and negative pressure.

The ProofMaster can be used to check the water resistance of both digital watches and analogue or pocket watches in accordance with the watch manufacturer's specifications.

You can also use the ProofMaster to build up positive pressure in the case of a leaky watch to then find the leak by testing it in water.

The device is intended for watches with the following maximum dimensions:

- Diameter: 70 mm
- Thickness: 30 mm
- Width: 85 mm

Proper use also includes observing all the information in the document. Any use that deviates from the proper use is considered improper use.

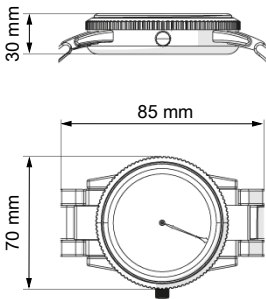

CAUTION



Risk of injury if the device is used improperly!

Improper use of the ProofMaster can result in hazardous situations.

2.3 Safety sign

The parts of the device which represent a danger are marked with a safety label.

Mandatory



Make sure that the safety labels on the device are clearly legible and clean!

If the labels become dirty or illegible over time, so that hazards can no longer be identified or service instructions can no longer be followed, they must be replaced with new ones and affixed to the same place.

2.3.1 Labels on the device

Calibration of the ProofMaster

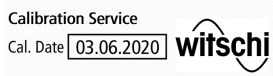

The stickers listed below are affixed to the ProofMaster.

The sticker on the underside of the device shows when the device was last calibrated.

Info



The reliability of the measurement results is guaranteed by regular calibration of the ProofMaster.

Maximum supply pressure



This sticker is located next to the connection point of the compressed air supply. The maximum supply pressure must not exceed **12 bar**.

2.3.2 Labels on the power supply unit

Electrical and electronic components



The labels below are affixed to the power supply unit.

The electrical and electronic components in the device contain toxic substances. The device must therefore be disposed of in a recycling depot or by a specialised company.

CE conformity



The "CE" marking confirms that this product complies with the European requirements regarding safety, health, environmental and user protection.

2.4 Residual risks

Compressed air

The compressed air devices can be dangerous if they are disconnected when compressed air is present. A pressurised line that is disconnected can cause the air to escape extremely quickly as a result of the escaping pressure, thus posing a danger, especially to the eyes and face.

 CAUTION



Risk of injury from compressed air!

If compressed air escapes uncontrolled, there is a risk of injury.

- Take care when working on the compressor or the compressed air hoses.

Prohibition



Do not exceed the maximum supply pressure of 12 bar!

Device components could otherwise burst.

Never force the device cover to open when the device is under pressure!

Otherwise parts could be ejected.

Mandatory



Follow the obligations set out below:

Check the compressed air hose before each use!

The integrity of the hose is crucial for safety.

Make sure that the compressed air hose is not subjected to any external mechanical loads!

The compressed air hose must therefore not come into contact with sources of heat, oils or greases, and must not be crushed, kinked, pinched or subjected to excessive tensile loads.

Before the unit is put out of operation, the compressed air supply must be completely disconnected!

To reduce the risk of damage from residual pressure in the unit.

Mandatory



Observe the documentation of the compressor manufacturer!

To avoid operating errors that can lead to damage.

Contaminated compressed air

Caution - material



Material damage due to the use of contaminated compressed air!

The use of contaminated compressed air can damage the device.

Mandatory



Follow the obligations set out below:

Only use oil-free, dry and dust-free air!

Ensures that no condensation water can enter into the device via the compressed air.

Service the compressor regularly as specified in the manufacturer's documentation!

Ensures operation with clean compressed air.

Cracked glass

 CAUTION



Risk of injury from cracked glass!

The positive pressure can penetrate into leaking watches during the test. If this is the case, the interior of the watches will be under pressure after the test. The glass in the watch can then splinter or crack. It can cause serious eye injuries and even blindness.

Moving parts

Mandatory



Observe the instructions for wearing safety goggles in this Operating instructions!

If it is necessary to wear safety glasses, make sure that other people in the room are at an appropriate distance from the device.

CAUTION



Risk of injury from moving parts!

Moving parts inside the device can cause serious injuries including loss of limbs.

Prohibition



Never open the device housing manually!

The housing may close again, trapping an object or part of the body.

Mandatory



Return a defective device to the manufacturer immediately!

To avoid damage of any kind.

Risk of crushing

CAUTION



Risk of crushing when closing the bell cover!

There is a risk of crushing between the bell cover and the housing of the device when closing the bell cover.

- Before closing the bell cover, make sure that no body parts or objects are inside the closing area.

Current

Caution - material



Material damage due to short circuit!

Damage to the insulation on the power cord or the power supply unit can result in a short circuit and damage the ProofMaster.

Prohibition



Never immerse the device in water!

It is not designed for immersion.

Mandatory



Follow the obligations set out below:

Work on electronic components of the ProofMaster must only be carried out by customer service!

Failure to do so could void the warranty.

Always disconnect the mains plug before cleaning, maintenance or repair work!

To avoid electric shock.

To disconnect the power supply unit from the power supply, only pull on the plug itself, never pull on the cable.

To avoid damage to the cable.

Observe the following recommendations to avoid short circuits:

- If the power cord or power supply unit is damaged, disconnect the mains plug and have the power supply unit repaired.

- Place the power cord so that it cannot be damaged by external influences.
- Ensure that access to the power supply is always guaranteed.
- Protect live parts from moisture.

Opening the housing

Caution - material



Material damage due to opening the housing!

When opening the housing, there is a risk that internal components of the device or the housing may be damaged.

Prohibition



Never open the housing yourself!

Opening the housing will void the warranty and Witschi Electronic AG will not be liable for any accident occurring after the housing has been opened by an unqualified person.

Mandatory



In the event of malfunctions or problems that cannot be solved with the help of these instructions, contact the manufacturer!

Failure to do so could void the warranty.

Test pressure

Caution - material



Material damage due to excessive test pressure!

Applying excessive test pressure can damage the watch being tested and/or the ProofMaster.

Prohibition



Do not exceed the maximum supply pressure of 12 bar!

Device components could otherwise burst.

Mandatory



Follow the obligations set out below:

Make sure that the watch can withstand the pressure!

To avoid damaging the watch.

Only check watches for which a maximum water depth is specified, without exceeding the limit value!

Observe the following rule: 10 m water depth = 1 bar test pressure.

Observe the test pressure values!

See section *Determining test pressure values* [Page 38].

Check watches without special information at a maximum pressure of 2 bar!

To avoid damaging the watch.

Water ingress

Caution - material



Damage to the watch being tested due to water ingress!

The watch will only remain sealed in the water as long as there is a positive pressure in the housing, and, if the leak in the watch is too large, there is a risk of water penetrating the interior of the watch during the water test.

Mandatory**Follow the obligations set out below:**

Only perform the water test once the "Leak Finder" program has been executed and the watch can be submerged in water without any risk!

Perform the test in the water immediately after the "Leak Finder" program has ended!

The watch can only be safely immersed in water for as long as there is positive pressure in the housing.

Witschi Electronic AG accepts no liability for watches that are penetrated by water.

If the display is red, remove the watch from the water!

The positive pressure in the watch is too low and water can penetrate.

Touchscreen**Caution - material****Material damage due to operating the touchscreen with sharp objects!**

The touchscreen can be damaged if it is operated with sharp objects (for example with ballpoint pens).

- Operate the touchscreen with the stylus provided for the purpose or with your fingers.

2.5 Owner's liability

The device is intended for commercial use. The user is therefore subject to the statutory obligations of occupational health and safety.

In addition to the safety instructions and warnings in these instructions, the applicable regulations regarding safety, occupational health and safety and environmental protection for the operation of the device must also be observed.

The following must be taken into account:

- The user must learn about the applicable occupational health and safety requirements and identify additional hazards as part of an assessment of the existing risks, depending on the specific working conditions at the device's site of operation. The user shall take account of this assessment to create operating instructions for the use of the device.
- Throughout the service life of the device, the user must ensure that the operating instructions which he or she has drawn up comply with current regulations and, if necessary, adapt them.
- The user must ensure that all persons who use the device have read and understood these instructions. In addition, the user must also ensure that personnel are regularly trained and informed of the hazards.
- The user must provide personnel with the required protective equipment and ensure that the required protective equipment is worn, see *Personal protective equipment* [Page 17].
- The owner must ensure that the service intervals specified in the instructions are complied with.
- The owner must ensure that the service intervals for the components (especially the compressor) are complied with.

2.6 Personnel qualifications

CAUTION



Risk of injury in the event of inadequate personnel qualifications!

If unqualified personnel carry out work on the device or stay in the device's danger zone, there is a risk of injury and significant material damage.

Mandatory



Follow the obligations set out below:

All activities may only be carried out by qualified personnel!

To avoid operating errors.

The operator of the device must have the appropriate knowledge and have completed the necessary training for the correct handling of watches!

In addition, during training, the operator must be informed by the user of the tasks assigned to him or her and of possible hazards in the event of improper behaviour. The operator may only carry out tasks that go beyond the scope of use in normal operation where this is specified during training and the user has specifically entrusted the operator to do so.

Unauthorised persons must keep a safe distance from the device!

To avoid unnecessary dangers.

2.7 Personal protective equipment

Personal protective equipment is a device or means worn or held by a person to protect him or her from one or more risks which could threaten his or her safety or health.

Safety goggles



Safety goggles protect the eyes from flying splinters of glass.

Safety goggles must be worn for the following activities, in particular:

- When removing the watch after a completed test.
- When preparing and carrying out the water test.

Mandatory



Observe the instructions for wearing safety goggles in this Operating instructions!

If it is necessary to wear safety glasses, make sure that other people in the room are at an appropriate distance from the device.

2.8 Spare parts

CAUTION



Risk of injury if incorrect spare parts are used!

The use of incorrect or defective spare parts can lead to hazards for personnel, material damage, malfunctions or even complete failure of the device.

- Only use original parts from Witschi Electronic AG or parts approved by Witschi Electronic AG.
- If unclear, contact customer service, see [Technical support](#) [[Page 7](#)].

Info



For a list of spare parts, see [Accessories and spare parts](#) [[Page 71](#)].

2.9 Noise emissions

The noise emissions from the ProofMaster are below 75 dB(A) and have been measured according to the guidelines EN ISO 3740:2001-03 and EN ISO 11200:2014-10.

3 Initial operation

3.1 Moving the device

CAUTION



Risk of injury and material damage due to improper transport!

In the event of improper transport, the device may fall or tip over. This may cause personal injury or serious damage to property.

Prohibition



Never transport the ProofMaster when it is connected or switched on!

Handling may be severely impaired and components of the device may be damaged.

Mandatory



Follow the obligations set out below:

Always transport the packages vertically and never throw them!

Observe the markings on the packaging!

Do not remove the ProofMaster from its packaging until shortly before commissioning!

The packaging protects the ProofMaster from external damage.

Always carry the ProofMaster by the carrying handle or with both hands!

Falling over is prevented.

Only technical personnel are authorised to install the ProofMaster!

The technical personnel are trained for proper installation.

3.2 Transport inspection

When accepting the device, check all components and make sure that no parts have been damaged during transport.

Additionally, check whether the device is complete.

Proceed as follows if there is visible transport-related damage:

- a) Do not accept the delivery.
- b) Make a note of the extent of the damage on the transport company's delivery note.
- c) Write a complaint.

Mandatory



Report damage or missing parts to Witschi Electronic AG immediately!

Claims for damages can only be made within the applicable claim periods.

3.3 Storage conditions

Store the device and package under the following conditions:

- Storage temperature -20 °C to +70 °C.
- Relative humidity maximum 80%, no condensation.
- Do not store outdoors.
- Store in a dry and dust-free condition.
- Do not expose to any aggressive media.
- Protect against sunlight.
- Protect against mechanical impact.
- Do not place anything on top of the device packaging.

3.4 Space requirement

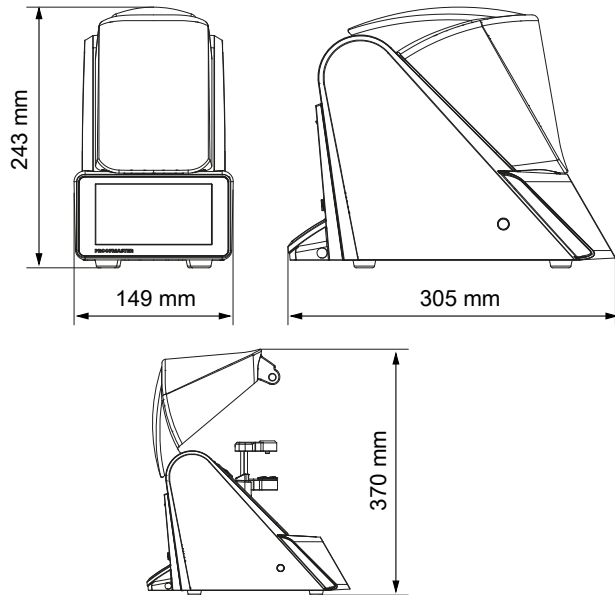

3.5 Requirements regarding the installation site

The ProofMaster is designed for use on a worktable in as dry and dust-free an environment as possible. The ProofMaster is not suitable for outdoor use.

Caution - material



The results of the tests may be incorrect in the case of an unsuitable installation location!

To achieve precise results, the ProofMaster and the test object must be at room temperature.

The following instructions must be observed for reliable measurements:

- Do not position the ProofMaster and test object in the vicinity of radiators or open windows.
- Do not expose the ProofMaster or the test object to direct sunlight.
- Use the ProofMaster on an even and horizontal surface.
- The installation site must be vibration-free.

3.6 Working area of the operator

In order for the operator to work comfortably, we recommend leaving at least 50 cm space on each side of the ProofMaster in order to place the watch shop there.

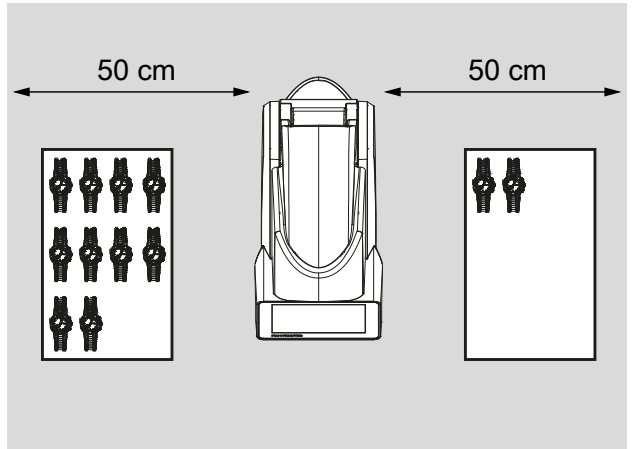

3.7 List of equipment

Equipment included in the scope of delivery of the ProofMaster

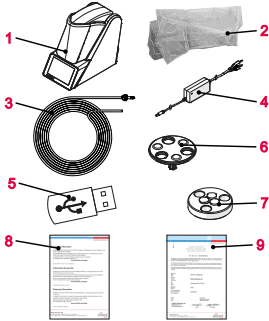

No.	Description	Function
1	ProofMaster	Measurement of the leak tightness of watches.
2	Protective cover	Protection of the ProofMaster from dust deposits.
3	Compressed air hose	Compressed air transfer from the compressor to the ProofMaster.
4	Power supply unit (12 VDC, 3 A)	Power supply for the ProofMaster.
5	USB stick with WiCoTRACE 3 LITE software	WiCoTRACE enables simple traceability of test results and measured values in a networked database-driven system.
6	Scratch Protect	Lowerable watch support for efficient protection against unwanted scratches.
7	Watch underlay	Stabilisation of watches < 20 mm during the leak tightness test.
8	Warranty information	Information about the warranty conditions.
9	Calibration certificate	

Additional equipment required for operation of the ProofMaster

No.	Description	Function
1	Compressor	Compressed air supply for the ProofMaster.

Optional additional equipment

No.	Description	Function
1	Thermal printer	Print test results without a PC.
2	WiCoTRACE 3 SERVER, SERVER+	Recording of test results and management of programs with a PC.

Info



To order accessories or spare parts, please contact the points of sale.

Your nearest point of sale can be found on the website www.witschi.com.

3.8 Initial operation

Initial operation of the ProofMaster includes connecting the power and compressed air supply and making all other connections for smooth operation (printer, network, etc.).

3.8.1 Current

Caution - material



Risk of material damage if an unsuitable power supply unit is used!

Using an unsuitable or damaged power supply unit can result in a short circuit. This may damage the device.

- Only use the power supply unit supplied with the device.
- Position the power cord so that it cannot be damaged by external influences.

Required equipment

Connecting

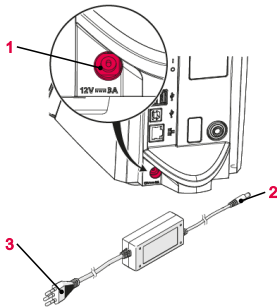

Disconnecting

- One ProofMaster
 - One power supply unit
- a) Make sure that the voltage of the local power supply is suitable for the power supply unit.
⇒ 115/230 V, 50 Hz, 1 A.
 - b) Connect the power supply unit connection **2** to the power supply connection of the ProofMaster **1**.
 - c) Connect the power supply unit connection **3** to the local power supply.
⇒ The power supply is now connected.
- a) Switch off the ProofMaster.
 - b) Disconnect the power supply unit connection **3** from the local mains network.
 - c) Disconnect the power supply unit connection **2** from the power supply connection of the ProofMaster **1**.
⇒ The power supply is now disconnected.

3.8.2 Compressed air

CAUTION



Risk of injury due to uncontrolled release of compressed air!

If compressed air escapes uncontrolled, there is a risk of injury.

- Do not exceed a supply pressure of 12 bar.
- Make sure that the compressor is suitable for operation with the ProofMaster.
- Observe the instructions from the compressor manufacturer.

Mandatory



Read and follow the instructions supplied with the compressor.

Only qualified persons who are trained in the operation of the compressor and familiar with the associated instructions may work on the compressor.

Recommended compressor Required equipment

Connecting

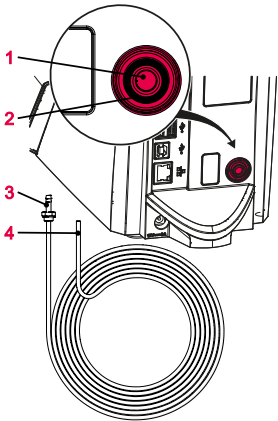

Disconnecting

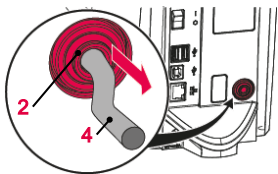

- See section *Accessories and spare parts* [Page 71].
 - ProofMaster
 - Compressed air hose
 - Compressor (not included in the scope of delivery of ProofMaster)
- Put the compressor into operation as specified in the manufacturer's instructions.
 - Make sure that the compressor is switched off and the outlet valve is closed.
 - Connect the coupling of the compressed air hose **3** to the compressor.
 - Insert the open end of the compressed air hose **4** into the compressed air plug connection of the ProofMaster **1**.
 - Check whether the compressed air hose **4** is properly fastened by gently pulling it.
 - Open the outlet valve of the compressor.
- ⇒ The compressed air supply is now connected.
- Close the outlet valve of the compressor.
 - Drain the air from the hose.
 - Press the ring **2** and pull the compressed air hose **4** out of the corresponding plug connection **1**.
 - Remove the coupling of the compressed air hose **3** from the compressor.
- ⇒ The compressed air supply is now disconnected.

3.8.3 Thermal printer

The following steps are only necessary when using a thermal printer.

Info



Read and follow the instructions supplied with the thermal printer.

**Recommended printer
Required equipment**

- See section *Accessories and spare parts* [▶ Page 71].
 - ProofMaster
 - Thermal printer (not included in the scope of delivery of ProofMaster)
 - Standard USB cable type **A-B** or a Bluetooth set II (not included in the scope of delivery of the ProofMaster). See *Accessories and spare parts* [▶ Page 71].
- a) Put the thermal printer into operation as specified in the manufacturer's instructions.
 - b) Ensure that the thermal printer and the ProofMaster are switched off.
 - c) Connect the USB cable **2** to the thermal printer USB type **B** inputs.
 - d) Connect the USB cable **2** to one of the two USB type **A** inputs on the ProofMaster **1**.
 - ⇒ The ProofMaster is now connected to the thermal printer.
 - e) Switch on the ProofMaster and configure the thermal printer.
 - ⇒ See *Configuring the printer* [▶ Page 92].

Connection with USB cable

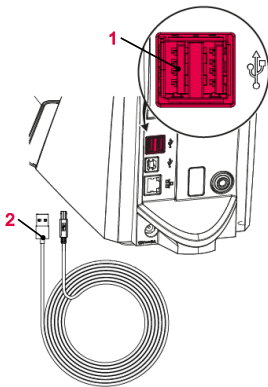

Connection via Bluetooth dongle

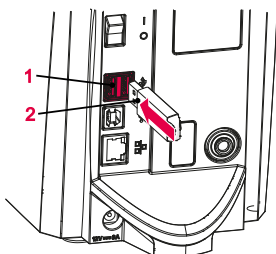

- a) Start the thermal printer incl. Bluetooth plug-in unit as specified in the manufacturer's instructions.
- b) Ensure that the thermal printer and the ProofMaster are switched off.
- c) Plug the USB adapter **2** into one of the two USB type **A** inputs of the ProofMaster **1**.
 - ⇒ The Bluetooth dongle is automatically recognised by the ProofMaster.
 - ⇒ Switch on the ProofMaster and configure the thermal printer.
 - ⇒ See *Configuring the printer* [▶ Page 92].

Disconnecting

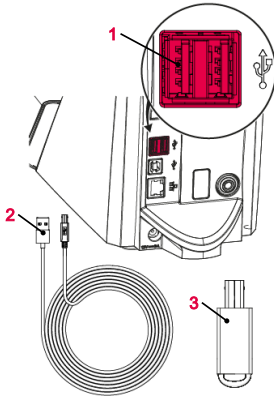

- a) Ensure that the thermal printer and the ProofMaster are switched off.
 - b) When connecting using a USB cable, disconnect it from the thermal printer.
 - c) Disconnect the USB cable **2** or the Bluetooth dongle **3** from the ProofMaster **1**.
- ⇒ The ProofMaster is now no longer connected to the thermal printer.
- ⇒ Configure the ProofMaster again without the thermal printer. See [Configuring the printer \[Page 92\]](#).

3.8.4 Network

Required equipment

The following steps are necessary when using a PC within a network.

- ProofMaster
- Ethernet cable (not included in the scope of delivery of ProofMaster)
- PC incl. network environment (not included in the scope of delivery of ProofMaster)

Connecting

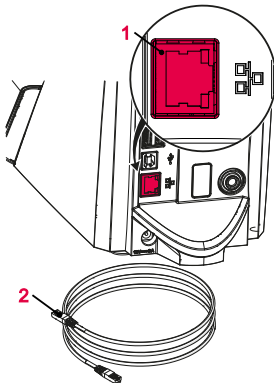

- a) Ensure that the ProofMaster is switched off.
 - b) Connect the Ethernet cable **2** to the network.
 - c) Connect the Ethernet cable **2** to the network connection **1** of the ProofMaster and switch on the ProofMaster.
- ⇒ The ProofMaster is now connected to the network.
- ⇒ For the configuration of the network, see the [Network settings \[Page 96\]](#) section.

Disconnecting

- a) Ensure that the ProofMaster is switched off.
 - b) Disconnect the Ethernet cable **2** from the network.
 - c) Disconnect the Ethernet cable **3** from the ProofMaster.
- ⇒ The ProofMaster is now no longer connected to the network.

4 Description

4.1 Proofmaster

Front view

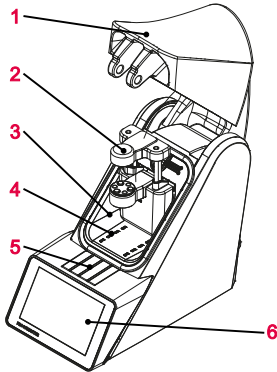

- 1 Bell cover
- 2 Deformation sensor
- 3 Test chamber
- 4 Compressed air inlet and outlet
- 5 Flap over catch
- 6 Touchscreen

The bell cover covers the test chamber. During testing, the bell cover **1** is closed and locked by the catch under flap **5**.

The bell cover opens and closes automatically before and after testing a watch.

Rear view

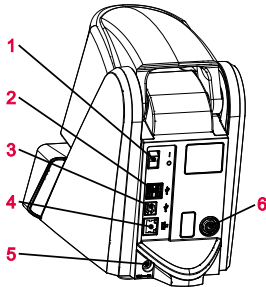

- 1 Main switch
- 2 2x USB type A ports
- 3 USB type B port
- 4 Network connection
- 5 Electrical connection
- 6 Compressed air plug connection

Test chamber

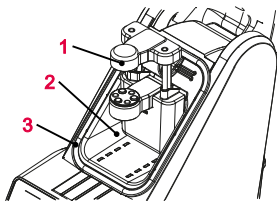

- 1 Deformation sensor
- 2 Test chamber
- 3 Seal (O ring)

The tightness test is performed in the test chamber **2**. The deformation sensor **1** and watch support are located inside the test chamber. When the test procedure is started, the bell cover closes so that it rests against the seal **3**. This ensures that the test chamber is sealed. The pressure required for the test can now be built up and maintained in the test chamber.

The pressure is built up by means of a compressor connected to the device inside the test chamber **2**. The vacuum is generated by a Venturi valve integrated in the device and the connected compressor.

Deformation sensor

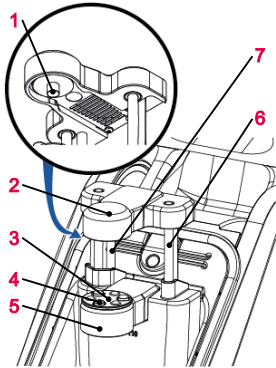

- 1 Measuring probe
- 2 Sensor head
- 3 Scratch Protect
- 4 Support points
- 5 Support table
- 6 Sensor guides
- 7 Driving rods

The deformation sensor makes it possible to measure the deformation of the watch. During the test, the watch is stabilised by the three support points **4** that are integrated in the support table **5**. If a small watch is being tested, the Scratch Protect **3** can be removed and the watch support can be placed on it. The sensor head **2** with the measuring probe **1** is located on the watch glass during the test and can thus measure how strongly the watch housing expands or contracts.

The sensor head **2** is raised or lowered automatically to the watch by the drive rods **7** when the bell cover opens or closes.

Control and display element

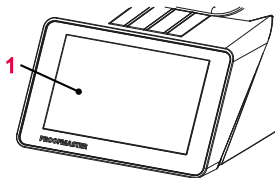

- 1 Touchscreen

Using the touchscreen, it is possible to navigate through the menus and edit the test settings. It also shows the progress and results of the test.

4.2 Included accessories

Power supply unit

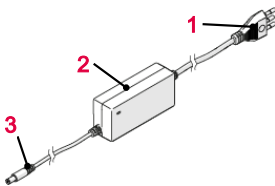

- 1 Power cable (country-specific)
- 2 Transformer
- 3 Electrical connection (device side)

Item no.: JA01-PSD40E120K3

The ProofMaster is connected to the mains via the power supply unit with the following characteristic data:

Description	Unit	Value
Input voltage	VAC	100 to 240
Input current	A	1.0

Description	Unit	Value
Input frequency	Hz	50 to 60
Output voltage	VDC	12
Output current	A	3.0

Compressed air hose

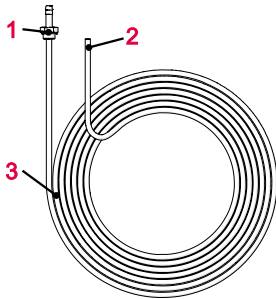

- 1 ARO 210 plug nipple (compressor side)
- 2 Open end (device side)
- 3 Compressed air hose

Item no.: 31.10.311

The compressed air hose is used to supply the ProofMaster with compressed air. The open end **2** is connected to the compressed air supply of the ProofMaster and the coupling **3** on the compressor.

Mandatory



The compressor connection must be compatible with the coupling of the compressed air hose!

- If necessary, replace the coupling supplied with the ProofMaster with a coupling compatible with the compressor.

The coupling supplied with the ProofMaster has the following characteristics:

Description	Type
Plug nipple	ARO 210

Watch underlay

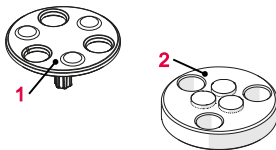

- 1 Scratch Protect
- 2 Watch support

Item no.: 31.24.702 (watch support) and 31.24.71.40 (Scratch Protect)

The standard support points are suitable for all watches > 20 mm. The Scratch Protect can also be used with these. This scratch protection only lowers the watch once the sensor head is moved to the support points. This prevents scratches when placing the watch.

Scratch Protect cannot be used on small watches because the danger of falling is too great.

Diameter of the watch glass	Watch underlay
$\varnothing_{\text{Glass}} > 20 \text{ mm}$	Scratch Protect 1
$\varnothing_{\text{Glass}} < 20 \text{ mm}$	Watch support 2

Protective cover



Item no.: 31.24.04.30.001

The dust cover covers the ProofMaster when not in use to protect it from dust deposits.

Mandatory



When not in use, always cover the ProofMaster with the corresponding dust cover.

This prevents the test chamber from leaking due to dust and dirt penetrating between the seal and bell cover.

4.3 Required accessories

Compressor

In order to use the ProofMaster, it must be connected to a compressor. The compressor must have the following characteristics:

Description	Unit	Value
ARO 210 coupling	-	-
Maximum outlet pressure	bar	12
Nominal outlet pressure for full operation of the ProofMaster	bar	11
Capacity of the compressed air tank	litres	Min. 4
Compressed air quality	-	Dry and clean (air filter)

Tip



Witschi Electronic AG has a compressor that is optimally suited for the ProofMaster.

JunAir 6–10 compressor 10 l, item no. 97.91.103 (230 VAC) and 97.91.104 (110 VAC).

- For further information, please contact a point of sale.

4.4 Optional accessories

Thermal printer

The test results can be printed out on the thermal printer. The thermal printer can be connected directly to the ProofMaster via the USB cable type A–B or the USB Bluetooth adapter. See *Thermal printer* [► Page 25].

Tip



Witschi Electronic AG provides the following components:

Thermal printer, item no. JB01-SLK-TE25-S.
Bluetooth adapter, item no. 95.1510.

- For further information, please contact a point of sale.

WiCoTRACE 3 software

With the WiCoTRACE 3 software, any ProofMaster connected to a network can be synchronised via a PC. In the software, all programs for the devices are combined and all measurement results from the connected devices are stored in the WiCoTRACE database. With the Universal Editor, programs can be created globally and used on any connected ProofMaster. Connecting to WiCoTRACE, see *WiCoTRACE* [► Page 97].

Tip



The WiCoTRACE 3 LITE software can be downloaded free of charge.

www.witschi.com

Bar code reader



The bar code reader can be used in conjunction with the **WiCoTRACE** software. The software can be used to create bar codes or QR codes for the various production orders. When the operator then scans a bar code or QR code, the program and the identification codes are automatically loaded into the ProofMaster.

For further details regarding the use of QR codes, see **WiCoTRACE** handbook, server database.

4.5 Procedure of a tightness test

A test may consist of several tests

If a test is performed with multiple tests, the following procedure is repeated.

Determining the initial value

After starting the test, the sensor head is moved into position and the starting value of the deformation is set to zero.

Build up pressure and record the deformation behaviour of the watch housing

The test pressure is built up in the test chamber. In order to compensate for pressure losses caused by the heating of the air, the test pressure is continuously regulated during the measurement.

The deformation behaviour of the watch is continuously recorded during pressure build-up and automatically included in the evaluation algorithm.

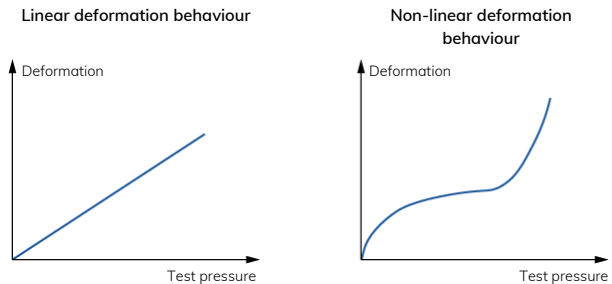

Automatic measuring time

The ProofMaster has a new evaluation algorithm which detects elastic deformation of watches and automatically compensates them.

In the standard setting, the ProofMaster automatically determines the required measuring time for each measurement. The software continues the measurement until a meaningful result is obtained.

The measurement time for a simple OK/not OK statement is shorter than the output of a precise leak rate. It should also be noted that smaller limits lead to longer measurement times. The maximum time per test pressure is limited to 300 seconds with automatic measuring time. For best results in terms of precision and test duration, we recommend the use of the automatic measurement time.

4.6 Definitions

Deformation measurement

The measuring method of the ProofMaster is based on the principle of deformation. The watch is subjected to positive pressure to compress the watch housing, or a vacuum to expand it. The faster the deformation is compensated, the larger the leak in the watch case. The deformation of the case within a certain time serves as the basis for the measurement to determine whether the watch is leakproof or not.

Leak-tight watch

Under constant pressure, the deformation of the watch housing remains constant.

Leaky watch

Under constant pressure, the deformation of the watch housing is reduced.

The difference between the pressure in the test chamber and the pressure in the watch housing is being compensated at a rate which is above the limits of the leak rate.

Limit

The limit represents the maximum permissible leak rate. If the leak rate exceeds the predefined limit, the watch being tested is classified as non-leak-tight.

Relative to the diameter of the watch housing, the following standard values apply:

Diameter of the watch glass	Volume	Limit
$\varnothing_{\text{Glass}} < 20 \text{ mm}$	1000 mm ³	50 µg/min
$20 \text{ mm} < \varnothing_{\text{Glass}} < 40 \text{ mm}$	2100 mm ³	
$40 \text{ mm} < \varnothing_{\text{Glass}}$	4000 mm ³	

Info



The lower the leak tightness limit, the longer the measurement takes.

This must be taken into account when planning production.

Leak rate

The ISO 22810 standard specifies the leak rate in µg/min and defines 50 µg/min as the limit value for leak tightness at a test pressure of 2 bar. The ProofMaster is configured by default according to these standard specifications.

To calculate the leak rate, the measuring algorithm needs the exact air volume in the watch case. The watch sizes suggested in the measuring program are suitable for a qualitative consideration – we recommend determining the inner volume of the watch beforehand. The inner volume can be determined from the watch's design data.

Info



Negative leak rate

A negative leak rate may be displayed at the start of the measurement.

A negative leak rate can be caused by a number of factors, e.g.:

- Elastic deformation of the test specimen;
- Thermal influences.

Over a longer measurement duration, the ProofMaster measurement algorithm compensates for these influences and displays a more accurate result. This makes it more reliable and faster than an algorithm used for conventional deformation measurement.

However, the end result may also display a negative leak rate. This usually occurs with leak-tight test specimens, in which case compensation cannot be fully performed. However, the reliability of the measurement is still guaranteed.

Significant negative leak rates indicate that the automatic compensation was insufficient for the test specimen. Manually setting a longer measurement time may remedy this.

If unclear, please contact customer service, see *Technical support* [[Page 7](#)].

4.7 Reference to standard ISO 22810

Leak-tight watch in accordance with standard ISO 22810

Standard ISO 22810 defines that a watch shall be classified as leak-tight if less than 50 µg of air penetrates the watch per minute at a test pressure of 2 bar.

Relationship between volume and deformation

The ISO 22810 standard does not take into account the volume of the watch. This means that the leak rate of 50 µg per minute applies to all watches, regardless of their size.

When testing according to the principle of deformation, the reversion depends on the free volume in the watch. In a watch with a small volume, the reduction in deformation is more pronounced with the same amount of penetrating air. The free volume must be programmed in the watch for a standard-compliant test.

Interpretation of ISO 22810

The standard is based on a pressure of 2 bar or 0.5 bar. No limit value is specified for other pressures. **It is therefore assumed that the limit of 50 µg per minute applies for all test pressures.**

5 Use

5.1 Safety during use

Cracked glass

CAUTION



Risk of injury from cracked glass!

The positive pressure can penetrate into leaking watches during the test. If this is the case, the interior of the watches will be under pressure after the test. The glass in the watch can then splinter or crack. It can cause serious eye injuries and even blindness.

Mandatory



Observe the instructions for wearing safety goggles in this Operating instructions!

If it is necessary to wear safety glasses, make sure that other people in the room are at an appropriate distance from the device.

Compressed air

The compressed air devices can be dangerous if they are disconnected when compressed air is present. A pressurised line that is disconnected can cause the air to escape extremely quickly as a result of the escaping pressure, thus posing a danger, especially to the eyes and face.

CAUTION



Risk of injury from compressed air!

If compressed air escapes uncontrolled, there is a risk of injury.

- Take care when working on the compressor or the compressed air hoses.

Prohibition



Do not exceed the maximum supply pressure of 12 bar!

Device components could otherwise burst.

Never force the device cover to open when the device is under pressure!

Otherwise parts could be ejected.

Mandatory



Follow the obligations set out below:

Check the compressed air hose before each use!

The integrity of the hose is crucial for safety.

Make sure that the compressed air hose is not subjected to any external mechanical loads!

The compressed air hose must therefore not come into contact with sources of heat, oils or greases, and must not be crushed, kinked, pinched or subjected to excessive tensile loads.

Before the unit is put out of operation, the compressed air supply must be completely disconnected!

To reduce the risk of damage from residual pressure in the unit.

Contaminated compressed air

Mandatory



Observe the documentation of the compressor manufacturer!

To avoid operating errors that can lead to damage.

Caution - material



Material damage due to the use of contaminated compressed air!

The use of contaminated compressed air can damage the device.

Mandatory



Follow the obligations set out below:

Only use oil-free, dry and dust-free air!

Ensures that no condensation water can enter into the device via the compressed air.

Service the compressor regularly as specified in the manufacturer's documentation!

Ensures operation with clean compressed air.

Risk of crushing



CAUTION



Risk of crushing when closing the bell cover!

There is a risk of crushing between the bell cover and the housing of the device when closing the bell cover.

- Before closing the bell cover, make sure that no body parts or objects are inside the closing area.

5.2 Basic operation

5.2.1 Switching on the Proofmaster

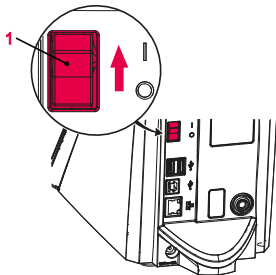

- ✓ The ProofMaster has been commissioned correctly, see *Initial operation* [▶ Page 23].
- a) Switch on the ProofMaster by pressing the switch **1** in the direction of the arrow.
 - ⇒ The home screen appears.
 - ⇒ The bell cover opens.

Info



When the ProofMaster is switched on for the first time, the display language can be selected on the displayed screen.

The display language can be changed at any time, see *Language selection* [▶ Page 74].

- ⇒ The "Programs" screen appears.
- b) Make sure that the pressure reducing valve of the compressor is set to a maximum of 11 bar, but at least 1 bar higher than the desired test pressure.
- c) Switch on the compressor as specified in the manufacturer's documentation.
 - ⇒ The Proofmaster is ready for operation.

5.2.2 Enabling screen saver or standby

Switching to screen saver or standby

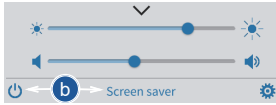
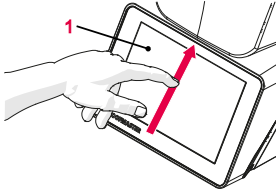

- ✓ The ProofMaster is switched on, see [Switching on the Proofmaster](#) [▶ Page 36].
- a) Swipe the touchscreen **1** with your finger in the direction of the arrow.
 - ⇒ The quick setup menu appears.
- b) Press "Screen saver" or tap  to switch the ProofMaster to standby.
 - ⇒ The bell cover closes and is locked.
 - ⇒ The ProofMaster is in standby or screen saver mode (standby screen is always black).
 - ⇒ The screen saver is displayed (date and time in this example).

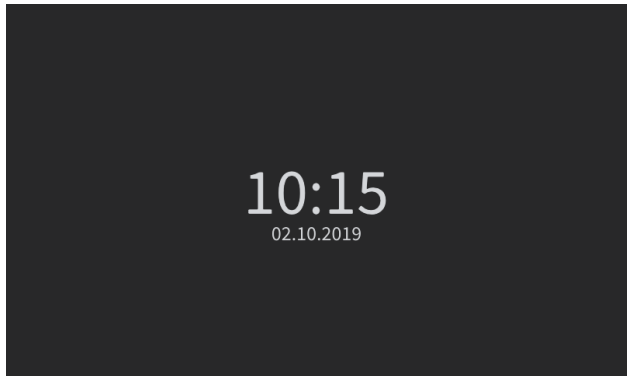

Tip



The screen saver is configurable.

See [Screen saver](#) [▶ Page 75].

Exiting screen saver/ standby

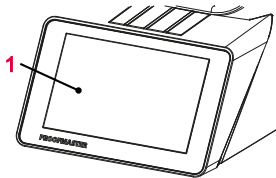

- ✓ The ProofMaster is in standby.
- a) Touch the touchscreen **1** to exit "Standby" or "Screen saver" mode.

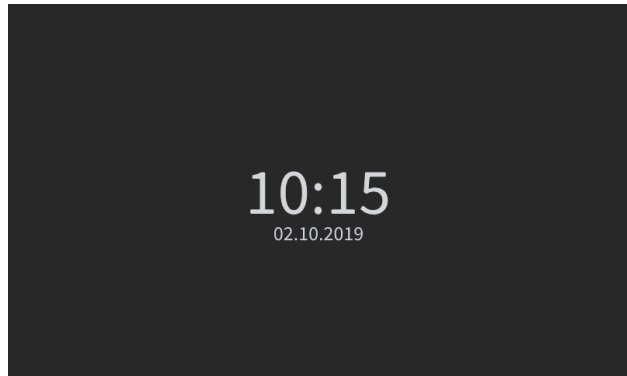

- ⇒ The bell cover opens.
- ⇒ The screen returns to the display that was active before switching to standby.

5.2.3 Switching off the device

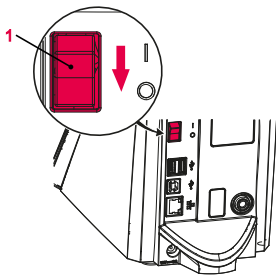

Tip



If the device is not used for a short period of time, enable standby mode.

See [Enabling screen saver or standby](#) [▶ Page 37].

- a) If necessary, remove the watch from the test chamber.
- b) Switch off the compressor as specified in the manufacturer's documentation.
- c) Enable the  mode, see [Enabling screen saver or standby](#) [▶ Page 37].
 - ⇒ The bell cover closes and is locked.
- d) Switch off the ProofMaster by pressing the switch **1** in the direction of the arrow.
- e) Cover the ProofMaster with the corresponding dust cover.

5.2.4 Determining test pressure values

Improper test pressure value settings

Caution - material



Risk of damaging the watch due to improper test pressure value settings!

Observe the following list of prohibitions and obligations.

Prohibition



Do not subject jewellery watches or thin watches to a pressure below -0.3 bar!

If jewellery watches or thin watches are subjected to an excessively strong vacuum, the base or glass of the watch may burst.

Prohibition

Never check a watch with a pressure greater than that specified in the specifications!

The force exerted may damage the watch and, in the case of flexible housings, even the movement.

Mandatory

Observe the table for the effect of force on the watch in order not to apply too high a pressure!

See Effect of force on the watch [▶ Page 39].

Specifications for test pressure value settings

Observe the following points to achieve optimum results:

- The pressure of the subsequent tests must always be greater than that of the previous test.
- Perform the vacuum test first. The vacuum test can be used to identify defects that cannot be detected by an overpressure test:
 - Insufficient leak tightness of the housing base.
 - Insufficient pressure of the battery cover on the seal.
- Only check watches for which a maximum water depth is specified, and do not exceed this limit value. Observe the following rule: 10 m water depth = 1 bar.
- Check wristwatches without special information at a maximum pressure of 2 bar.

Effect of force on the watch

Watch size	Vacuum (bar)			Pressure (bar)			
	(Dia. in mm)	-0.2	-0.4	-0.7	1.0	2.0	5.0
< 20	5.9 N	12.7 N	21.6 N	31.4 N	61.8 N	154.0 N	307.9 N
< 28	11.8 N	24.5 N	42.4 N	60.8 N	120.6 N	302.0 N	604.1 N
< 36	19.6 N	40.2 N	69.6 N	100.0 N	200.1 N	499.2 N	998.3 N

Vacuum

The ProofMaster can generate a maximum vacuum of 85% compared to the ambient pressure. The maximum vacuum that can be generated therefore varies depending on the height at which the ProofMaster is operated.

The following table shows the maximum vacuum that can be generated depending on the altitude:

Altitude (m)	0	500	1000	1500	2000
Maximum vacuum that can be generated (bar)	-0.85	-0.81	-0.76	-0.72	-0.68

Info

If the vacuum cannot be reached, the following message will appear: "No or insufficient inlet pressure available."

5.2.5 Programming a quick test

Test pressure

- ✓ The ProofMaster shows the home screen.

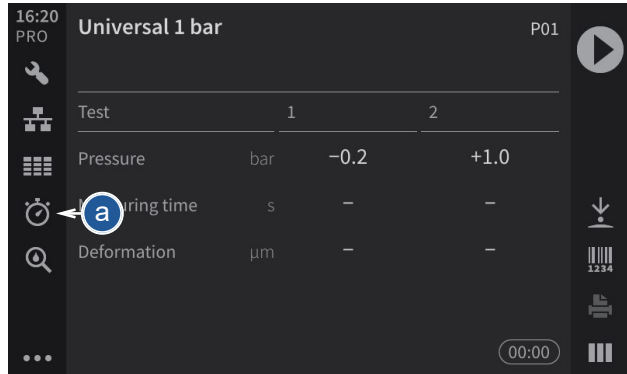

a) Press 

⇒ The Quick Select screen appears.

b) Tap **Pressure**.

⇒ The selection of the test pressure values appears.

c) Press the desired test pressure or press **Manual**.

⇒ The test pressure is programmed or a number field appears when **Manual** is selected.

d) For an individual test pressure, enter the desired test pressure value between -0.7 bar and 10.0 bar and then press  to confirm the entry.

⇒ The individual test pressure is programmed.

e) Press **Watch size** to program the size of the watch.

⇒ The selection of the watch sizes appears.

f) Press the value corresponding to the size of the watch glass.

g) If necessary, press **Vacuum test** to perform a vacuum test before the pressure test.

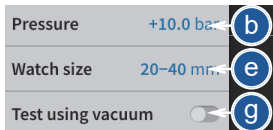

+2.0
+3.0
+5.0
+10.0
Manual

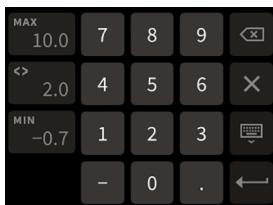

<20
20-40
>40

Info



The pressure for the vacuum test is fixed.

The pressure for the vacuum test is -0.3 bar and cannot be changed.

⇒ The **Vacuum test** button is displayed in blue.

Quick test programmed

The programmed values **1** are displayed **2** and the ProofMaster is ready for a test.

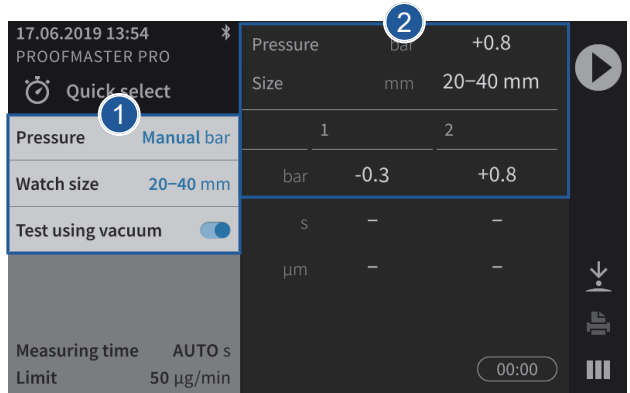

5.2.6 Selecting the program

Quick select

The Quick Select is used for single tests or for a single watch. Essentially, the Quick Select is intended for a watchmaker who, for example, wants to check a watch before or after a repair.



Pressure	+10.0 bar
Watch size	20–40 mm
Test using vacuum	<input type="checkbox"/>

- Press 
 - ⇒ The Quick Select screen appears.
- Program the test.
 - ⇒ See *Programming a quick test* [▶ Page 40].

Programs

The programs are usually used in production to perform measurements on a series of identical watches.



- Press 
 - ⇒ The program selection screen appears.

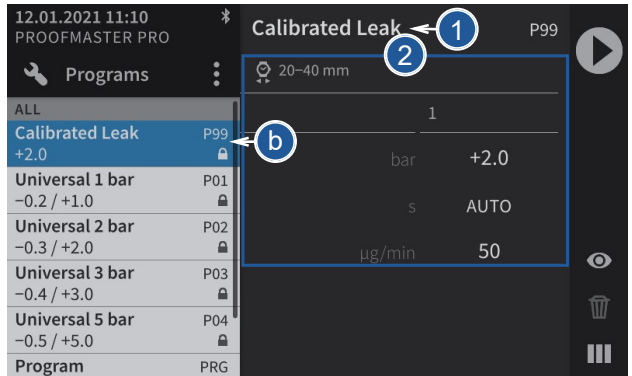

b) Press the desired program in the list.

- ⇒ The program is selected and its name **1** and parameters **2** are displayed.

5.2.7 Starting the test

a) Select the program.

- ⇒ See *Selecting the program* [▶ Page 42] and/or *Programming a quick test* [▶ Page 40].

CAUTION



Observe all safety regulations for the test pressures in order to avoid accidents and damage to the ProofMaster!

See *Safety regulations* [▶ Page 14].

b) Positioning a watch on the support.

- ⇒ See *Positioning the watch* [▶ Page 44].

c) Press to start the test.

- ⇒ The bell cover closes and the test begins.

Info



If one of the test steps fails, the entire test is considered a failure and is aborted immediately.

The bell cover opens.

d) Follow the test procedure.

- ⇒ See *Displaying test results* [▶ Page 47].

e) Wait until the bell cover is open.

- ⇒ The bell cover opens automatically at the end of the test.

f) Read the test result.

- ⇒ See *Displaying test results* [▶ Page 47].

Prohibition



Do not test a leaky watch twice in a row!

Due to the residual pressure inside the watch, the results would be distorted.

Open the watch before the second test to allow the positive pressure to escape.

- g) Remove the watch from the ProofMaster.

5.2.8 Cancelling the test

- a) Press  to stop the test.
 ⇒ The test is stopped, the pressure is released and the bell cover opens.

5.2.9 Positioning the watch

Temperature

Mandatory



The watch must be exposed to the same ambient temperature as the ProofMaster during the test.

Temperature fluctuations in the housing during testing may affect the test result.

- Keep the watch next to the ProofMaster before testing.
- If the watch has come directly from the user, wait until it has reached the ambient temperature.

Positioning the watch

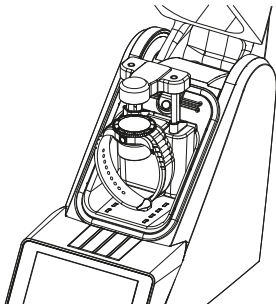
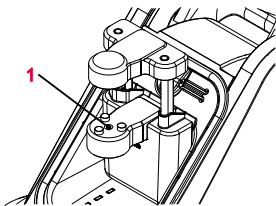

- a) Insert the appropriate watch underlay into the opening **1** provided for this purpose.

⇒ See *Included accessories* [▶ Page 29].

- b) Remove the protective sticker or label from the housing.

- c) Mount the watch on the watch underlay and pay attention to the following points.
 d) If the watch back is not flat, turn the watch over and place the glass side on the watch underlay.
 e) Position the watch so that the measuring probe can be lowered onto the centre of the watch.

Tip



It is possible to lower and lift the sensor manually.

See *Manually lowering/lifting the sensor* [▶ Page 45].

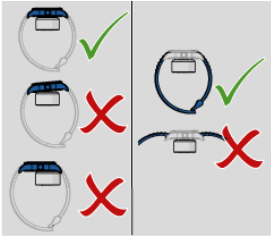

- a) Position the watch strap so that the watch is lying securely on the watch underlay. If necessary, remove the watch strap.
- b) Make sure that the watch strap does not come into contact with any parts of the device.
 - ⇒ The watch is positioned horizontally on the three support points.

5.2.10 Manually lowering/lifting the sensor

Depending on the selected menu, it is possible to lower and lift the sensor manually.

Lowering the sensor

- a) Press  to lower the sensor head **1** onto the watch **2**.

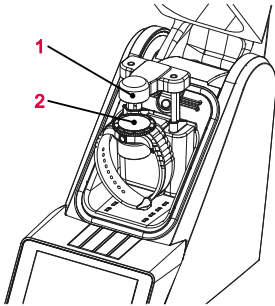

Lifting the sensor

- a) Press  to lift the sensor head **1**.

5.2.11 Identifying the tests

All measurements are identified by the measured test specimen (model). It is possible to add further identification elements:

- Prefix (for example, part number)
- User
- Comment (4 lines with maximum 32 characters)

Enabling identification

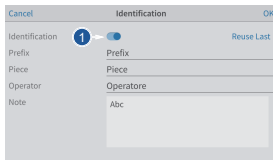

Entering the identification settings

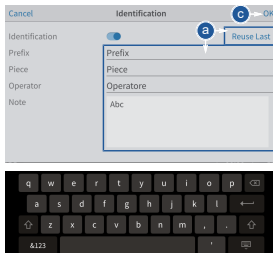

- Press  to open the identification window.
- Enable the identification.
 - ⇒ The button **1** is blue when the function is enabled and grey when it is not.
 - ⇒ The identification parameters entered are saved with the measurement result and also printed on the label.

✓ **The program is selected, Identification is enabled and the Identification menu is displayed.**

- Press **Apply last entries** to fill in the input fields with the settings from the last measurement, or press one of the input fields to open the alphanumeric keypad.
- If necessary, enter the desired settings.
 - ⇒ Use the alphanumeric keypad.
- Press **OK** to confirm the entry.
- Press  to perform the measurement.

5.3 Measurement results

5.3.1 Displaying test results

Info



The only result of a leak test to be displayed is whether the test is good or bad. However, it is also possible to enable leak rate measurement.

See *Creating a program (ProofMaster PRO)* [▶ Page 59].

Test area

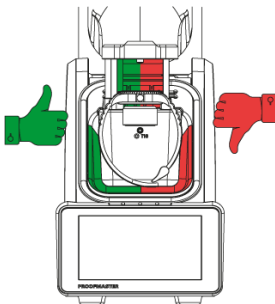

When the bell cover is opened after a leak test, the test area is illuminated green if the test result is good and red if the test result is bad.

Display

Two display types are available for the test result. See *Selecting the results display* [▶ Page 49].

Numerical display

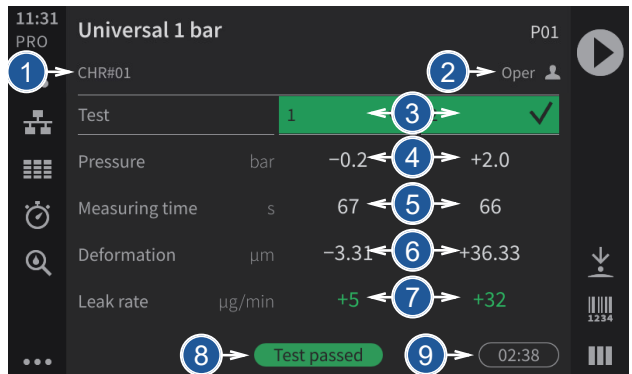

The numeric display provides the following information:

- 1 Test specimen prefix
- 2 Name of the operator (only with enabled identification, in the example above **Opera**)
- 3 Progress and result of each test step
- 4 Pressure values of each test
- 5 Measuring times of each test

- 6 Measured deformations for each test
- 7 Leak rate (only in Precise mode)
- 8 End result of the test
- 9 Total testing period

The following examples show possible display phases.

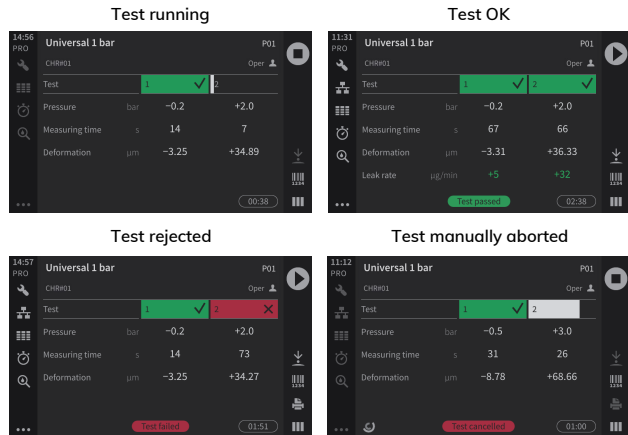

Reduced display

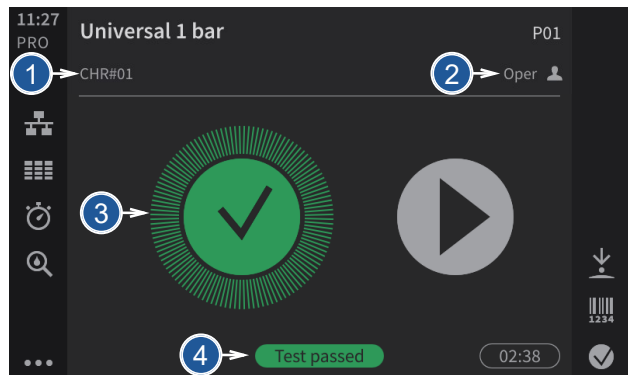

The reduced display provides the following information:

- 1 Test specimen prefix
- 2 Name of the operator (only with enabled identification, in the example above **Opera**)
- 3 Progress and result of each test step
- 4 End result of the test

In the examples below, the first test is running, the second test result is OK and the third test result is not OK.

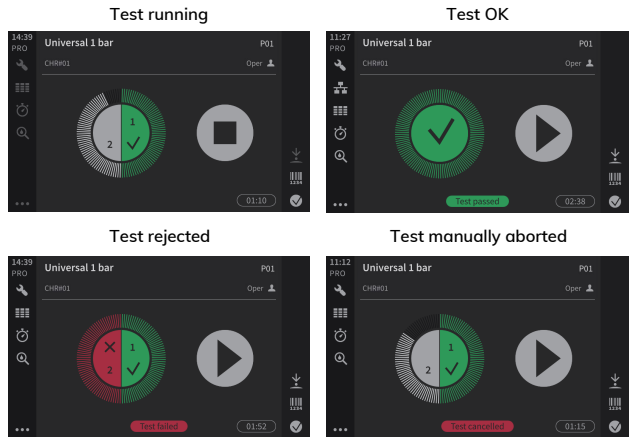

5.3.2 Selecting the results display

The results can be displayed in numeric or reduced form.

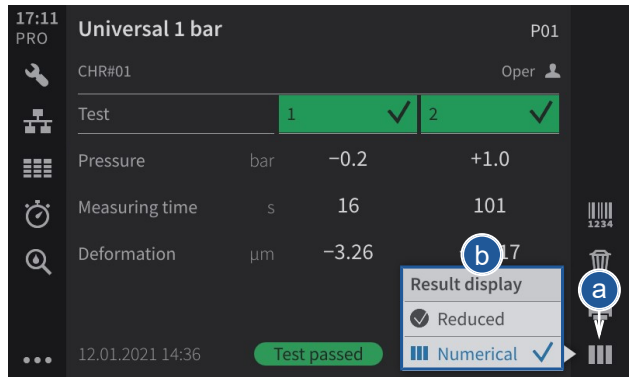

a) Press or (at the bottom right of the screen) to open the display selection window. The icon changes according to the selected display.

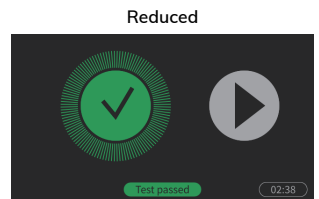
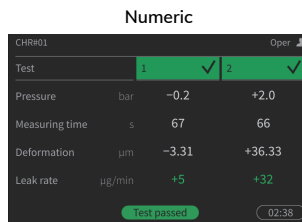

- b) In the Display result window, choose between Reduced or Numeric.

5.3.3 Access to results (ProofMaster PRO)

Info



This function is available in the ProofMaster PRO software version.

The ProofMaster stores the last 100 test results in the memory.

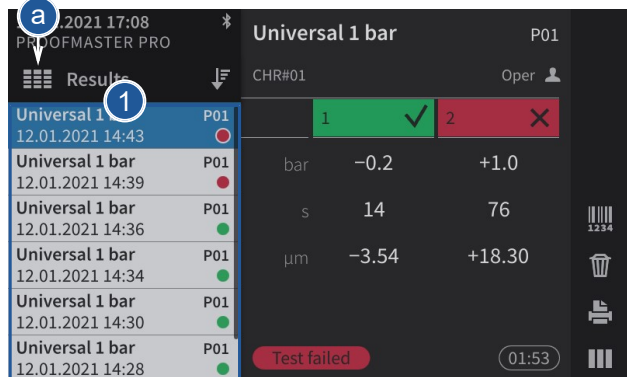

The screenshot shows the 'Results' screen in ProofMaster PRO. The top navigation bar has a list icon circled in red with the number '1'. Below the navigation bar, a list of test results is shown. The first entry is highlighted in blue. To the right, a detailed view of the selected test is displayed, showing a 'Test failed' message in a red box.

Test ID	Time	Status	Result 1	Result 2
Universal 1 bar	12.01.2021 14:43	●	1 ✓	2 ✗
Universal 1 bar	12.01.2021 14:39	●	bar -0.2	+1.0
Universal 1 bar	12.01.2021 14:36	●	s 14	76
Universal 1 bar	12.01.2021 14:34	●	μm -3.54	+18.30
Universal 1 bar	12.01.2021 14:30	●		
Universal 1 bar	12.01.2021 14:28	●		

- a) Press  to access old results.
 ⇒ The window with the results appears **1**.

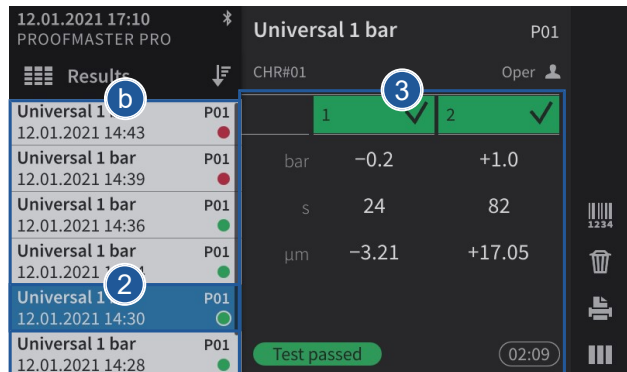

The screenshot shows the 'Results' screen in ProofMaster PRO. The list icon is circled in blue with the number '2'. The second entry in the list is highlighted in blue. To the right, a detailed view of the selected test is displayed, showing a 'Test passed' message in a green box. A red circle '3' highlights the detailed view.

Test ID	Time	Status	Result 1	Result 2
Universal 1 bar	12.01.2021 14:43	●	1 ✓	2 ✓
Universal 1 bar	12.01.2021 14:39	●	bar -0.2	+1.0
Universal 1 bar	12.01.2021 14:36	●	s 24	82
Universal 1 bar	12.01.2021 14:30	●	μm -3.21	+17.05
Universal 1 bar	12.01.2021 14:28	●		

- b) Press the desired result in the list.
 ⇒ The result selected from the list is highlighted in blue **2** and the results of the selected test are displayed **3**.

Tip



It is possible to sort the measurement results.
 See Sorting results (ProofMaster PRO) [P Page 51].

5.3.4 Sorting results (ProofMaster PRO)

Info

This function is available in the ProofMaster PRO software version.

✓ Display in the Results menu.

The screenshot shows the 'Universal 1 bar' test results. The 'Results' menu is open, and a blue circle 'a' highlights the sort icon (three horizontal lines with a downward arrow). The results table is as follows:

Time	Status	1	2
12.01.2021 14:43	P01 (Red)	1 (Green ✓)	2 (Red ✗)
12.01.2021 14:39	P01 (Red)	bar -0.2	+1.0
12.01.2021 14:36	P01 (Green)	s 14	76
12.01.2021 14:34	P01 (Green)	µm -3.54	+18.30
12.01.2021 14:30	P01 (Green)		
12.01.2021 14:28	P01 (Green)		

- a) Press to select the sort type.
 ⇨ The selection window for the sort type appears.

The screenshot shows the 'Sort' selection window. A blue circle 'b' highlights the 'Title' option, which is selected with a checkmark. A blue circle 'c' highlights the 'Results' menu icon. The results table is the same as in the previous screenshot.

- b) Press the desired sort type in the list (in the above example, **Title**).
 ⇨ The results are sorted according to the selection of the sorting (in the above example, **Title**).
- c) Press to close the sort type selection window.

5.3.5 Deleting measurement results (ProofMaster PRO)

Info



This function is available in the ProofMaster PRO software version.

- Call up a result that you want to delete.
 - ⇒ See Access to results (ProofMaster PRO) [Page 50].
- In the list, press the result that is to be deleted.
 - ⇒ The result selected from the list is highlighted in blue.

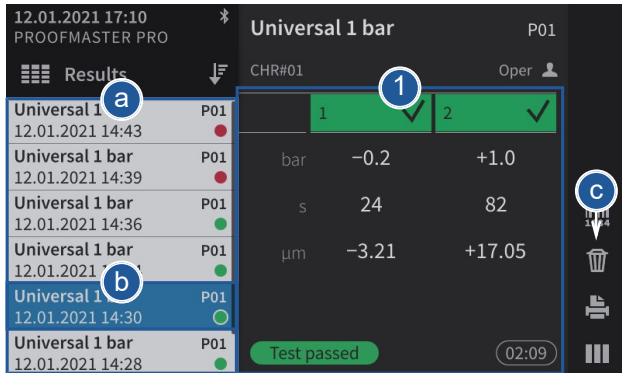

The screenshot shows the 'Universal 1 bar' results page. On the left, a list of results is shown with columns for 'Results', 'CHR#01', and 'Oper'. One result is highlighted in blue. On the right, a detailed view of the selected result is shown with columns for '1' and '2'. A 'Test passed' indicator is visible at the bottom of the detailed view.

Results	CHR#01	Oper
Universal 1 bar	P01	
Universal 1 bar	P01	
Universal 1 bar	P01	
Universal 1 bar	P01	
Universal 1 bar	P01	
Universal 1 bar	P01	
Universal 1 bar	P01	
Universal 1 bar	P01	

1	2
bar	-0.2 +1.0
s	24 82
µm	-3.21 +17.05

Tip



It is possible to sort the measurement results.

See Sorting results (ProofMaster PRO) [Page 51].

- The results of the selected test are displayed **1**.
 - Press  to select the deletion type.
 - ⇒ The selection window for the deletion type appears.
 - Press **Yes** to delete the selected result, **No** to cancel the deletion and **Delete all** to delete all results of the ProofMaster. (No results in WiCoTRACE are deleted.)

Delete result?

Yes

No

Delete all

5.4 LeakFinder (ProofMaster PRO)

Info



This function is available in the ProofMaster PRO software version.

To locate a leak, the ProofMaster uses the **LeakFinder**. This program creates a positive pressure inside the watch case. When the watch is then placed in a container filled with water, the rising bubbles indicate the point of leakage.

The **LeakFinder** program can also be used without a previous leak test.

Mandatory



Wear safety goggles during the entire leak detection process!

Pressure is applied to the inside of the watch. This can cause the watch glass to burst.

Pressurising the watch

✓ The result of the leak test of a watch was "bad".

a) Press to enter **LeakFinder** mode.

⇒ The **LeakFinder** window appears.

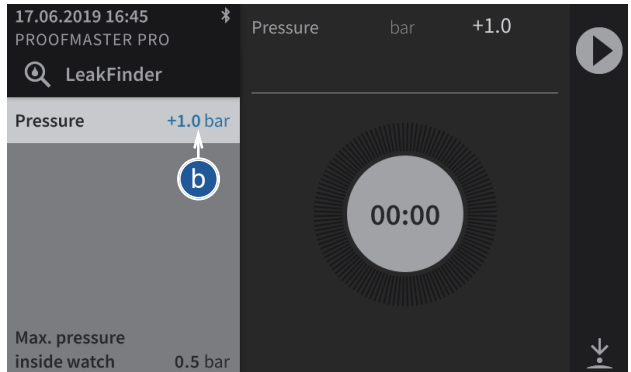

b) To define the test pressure, press on the pressure value (blue).

⇒ A number field appears.

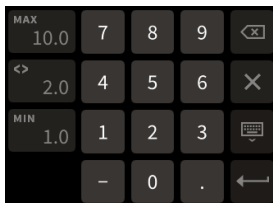

CAUTION



Observe all safety regulations for the test pressures in order to avoid accidents and damage to the watch or the ProofMaster!

See *Safety regulations* [▶ Page 14].

c) Enter the desired test pressure between 1.0 bar and 10.0 bar and then press to confirm the entry.

⇒ The test pressure is programmed.

d) Place the watch you want to test in the ProofMaster.

⇒ See *Positioning the watch* [▶ Page 44].

- e) Press  to pressurise the watch.
 ⇒ The bell cover closes.

Info



The process can last up to 10 minutes.

- f) Wait until the bell cover opens.
 ⇒ The time shown in blue is the time available to place the watch in distilled water and search for the leak without the risk of water penetrating the watch.

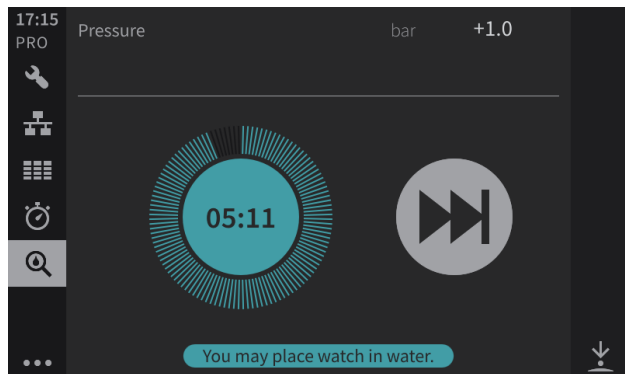

Tight or very small leak!
 It can take a long time until the watch is filled with the necessary pressure.

Cancel Continue

Maximum filling time exceeded!

The watch is tight or has a very small leak. The required pressure in the watch could not be reached to find a leak.

Close

- ⇒ When this message is displayed, the leak is very small. The ProofMaster asks whether it should continue with to build up pressure, which can take a long time, or cancel the process and resume it at a later time. Press **Cancel** to cancel pressure build-up or press **Continue** to continue.
- ⇒ When this message is displayed, the leak is so small that the watch is considered to be tight or leak detection is not possible. The ProofMaster releases the pressure from the bell cover and the bell cover opens.

- g) Remove the watch and locate the leak.

Locating the leak

Caution - material



Damage to the watch being tested due to water ingress!

The watch will only remain sealed in the water as long as there is a positive pressure in the housing, and, if the leak in the watch is too large, there is a risk of water penetrating the interior of the watch during the water test.

Mandatory



Follow the obligations set out below:

Only perform the water test once the "Leak Finder" program has been executed and the watch can be submerged in water without any risk!

Perform the test in the water immediately after the "Leak Finder" program has ended!

The watch can only be safely immersed in water for as long as there is positive pressure in the housing.

Witschi Electronic AG accepts no liability for watches that are penetrated by water.

If the display is red, remove the watch from the water!

The positive pressure in the watch is too low and water can penetrate.

✓ **The watch has been pressurised.**

- a) Fill a transparent container with water.

Tip



Use distilled water to avoid limescale deposits on the watch.

- b) Place the watch in the container.

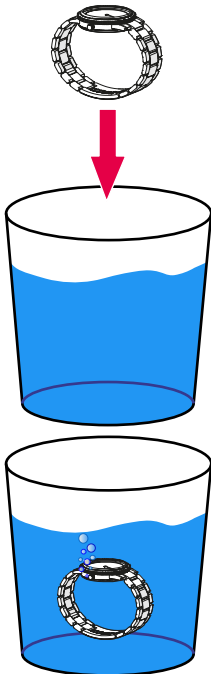

- c) Observe the formation of bubbles to locate the leak.

Info



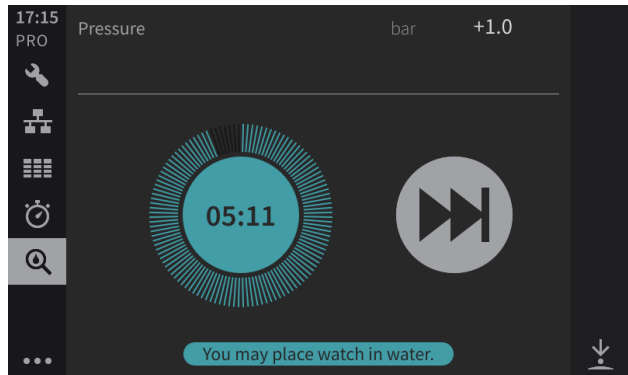

If the leak is very small, the formation of bubbles takes a few minutes.

- ⇒ The time shown in blue is the time available to locate the leak without the risk of water penetrating the watch.

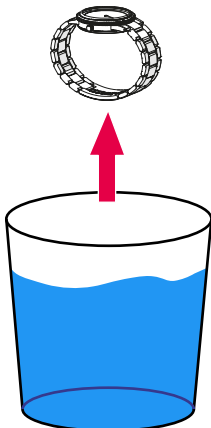
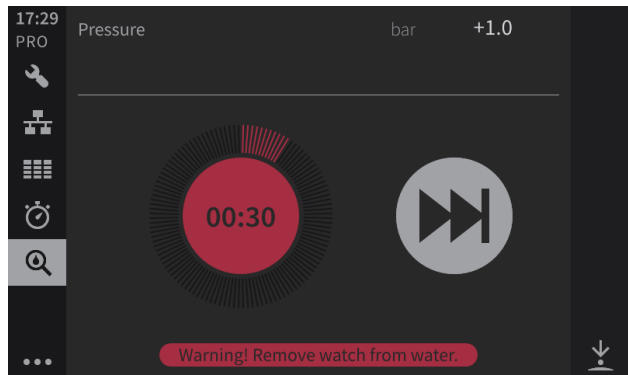

⇒ When the remaining time is 30 seconds or less, the time display will turn red, indicating that the watch must be removed from the water to avoid the risk of water penetrating the watch.



d) Once the leak is located, the number of bubbles decreases or 30 seconds remain, remove the watch from the water and press  to end the countdown on the ProofMaster.

5.5 Programming

5.5.1 Menus and operating buttons

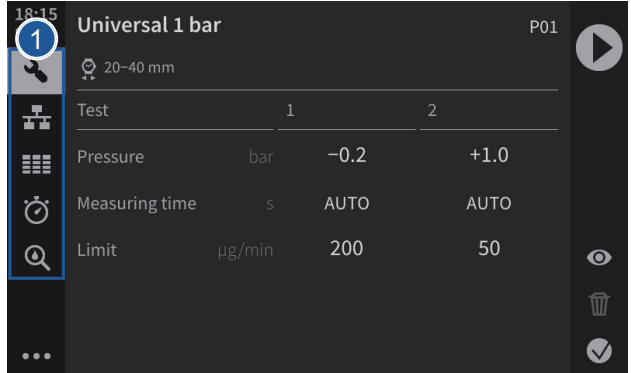

The various function menus can be accessed by pressing the corresponding button **1**:



Programs menu



WiCo menu (appears only when WiCoTRACE is enabled)



Results menu (ProofMaster PRO)



Quick Select menu



Leak test menu (ProofMaster PRO)

Functions of the buttons



Start a test sequence



Stop a test sequence



End the countdown



Creating a user program (ProofMaster PRO)



Numerical display



Reduced display



Expand the menu



Reduce the menu



Bluetooth connection



Lower the sensor



















Lift the sensor



Editing a program (ProofMaster PRO)



Deleting (ProofMaster PRO)

	Print a label
	Identification options (ProofMaster PRO)
	Programs menu options
	Sorting options
	Display settings of the current program
	Administrator mode
	User mode
	Select
	Back
	Selected option
	Favourites
	Export
	Import
	Reset
	Standby
	Settings

5.5.2 Preset programs

The ProofMaster offers two types of programs:

- **Preset programs:** Programs predefined by the manufacturer
These are marked with the  symbol.
- **Customer programs (ProofMaster PRO):** Free definition of all parameters
Each newly created program is therefore a customer program.

Abbreviation	Program name	Info on program
P01	Universal 1 bar	Minimum pressure for delicate watches or watches that deform significantly (e.g. plastic watches).
P02	Universal 2 bar	Universal test for all types of watches that are classified as waterproof. Corresponds to the 2 bar test as per ISO 22810:2010-4.4 and ISO 6425:2018-B.1.1.
P03	Universal 3 bar	For all types of watch that are classified as water-resistant to 3 ATM/30 m.
P04	Universal 5 bar	For all types of watch that are classified as water-resistant to 5 ATM/50 m.
P05	Universal 10 bar	For all types of watch that are classified as water-resistant to 10 ATM/100 m or more.
P99	Calibrated Leak	For testing the function of the ProofMaster in combination with Witschi reference leaks.

Parameters for the preset programs

Abbreviation	Program name	Pressure values (bar)	Limit values (µg/min)	Watch size (mm)
P01	Universal 1 bar	-0.2 / 1.0	200 / 50	20 - 40
P02	Universal 2 bar	-0.3 / 2.0	200 / 50	
P03	Universal 3 bar	-0.4 / 3.0	200 / 50	
P04	Universal 5 bar	-0.5 / 5.0	200 / 50	
P05	Universal 10 bar	-0.7 / 1.0 / 10.0	200 / 200 / 50	
P99	Calibrated Leak	2.0	50	

Info



The 50 µg/min limit is only applied at the highest test pressure of a program, as per ISO 22810. The previous test pressures are tested for the preliminary test with a limit of 200 µg/min.

5.5.3 Creating a program (ProofMaster PRO)

Info



This function is available in the ProofMaster PRO software version.

Creating a program

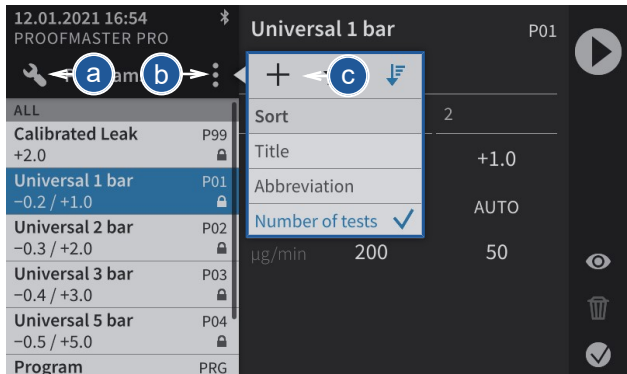

- Press to display the program menu options.
- Press to open the program menu options.
- Press to create a new program and open the basic programming window.

Basic programming

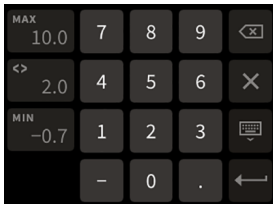
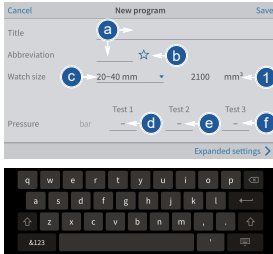

Advanced programming

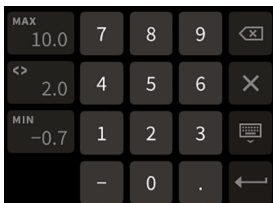
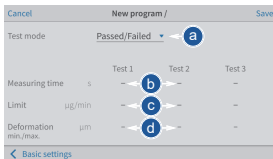

a) Give the new program a name and, if necessary, a short name.

- ⇒ An alphanumeric keypad appears for entering the names.
- b) Press  to mark the program as a Favourite.
 - ⇒ The star is filled in if the option is enabled and empty if the option is disabled.
- c) Select the watch size from the list.
 - ⇒ The volume used as the basis for the test is displayed **1**.
- d) Enter the pressure for the first test.
 - ⇒ A number field appears for the input of the pressure.
- e) If necessary, enter the pressure for the second test.
 - ⇒ A number field appears for the input of the pressure.
- f) If necessary, enter the pressure for the third test.
 - ⇒ A number field appears for the input of the pressure.

Info



To guarantee test results, the pressure of a test must always be greater than that of the previous test.

When saving the program, the ProofMaster arranges the test sequence starting with the test with the lowest pressure value and ending with the test with the highest pressure value.

- g) Press **Advanced parameters** to enter the advanced programming screen or **Save** to save the program.
- a) In test mode, select **Precise** to enable leak rate measurement.
 - ⇒ In addition to the result of the leak test (good or bad), the leak rate is displayed.
 - ⇒ Displaying a leak rate in "Precise" test mode requires more time for the measurement.
- b) If necessary, set a test time for each test.
 - ⇒ Entering a manually set measuring time may mean that the measurement algorithm cannot identify enough measuring points to produce a reliable measurement result. The user must therefore ensure that the selected measuring time enables the required test accuracy to be met.
 - ⇒ A number field appears for entering the times.
- c) If necessary, set a maximum leak rate test in $\mu\text{g}/\text{min}$ for each test.
 - ⇒ A number field appears for entering the leak rates.
- d) If necessary, set the minimum and maximum deformation limit in μm for each test.
 - ⇒ A number field appears for entering the minimum and maximum deformation.
- e) Press **Basic settings** to enter the basic programming screen or **Save** to save the program.

5.5.4 Editing a program (ProofMaster PRO)

Info

This function is available in the ProofMaster PRO software version.

- a) Select the user program to be edited.
 ⇒ See [Selecting the program](#) [▶ Page 42].

Programs		Program		PRG
Universal 1 bar -0.2 / +1.0	P01	1	2	 b
Universal 2 bar -0.3 / +2.0	P02	bar	-0.8 +2.0	
Universal 3 bar -0.4 / +3.0	P03	s	AUTO AUTO	
Universal 5 bar -0.5 / +5.0	P04	µg/min	50 50	
Program -0.8 / +2.0	PRG			
Universal 10 bar -0.7 / +1.0 / +10.0	P05			

- b) Press to display the user program configuration window.
- c) Change and save the desired settings.
 ⇒ See the **Basic programming** and **Advanced programming** sections of the [Creating a program \(ProofMaster PRO\)](#) [▶ Page 59] procedure.

5.5.5 Deleting a program (ProofMaster PRO)

Info



This function is available in the ProofMaster PRO software version.

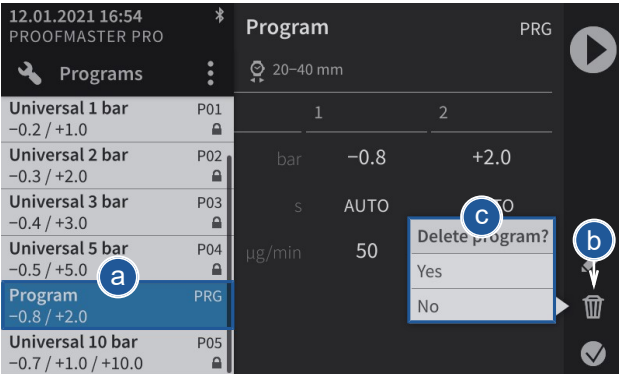

The screenshot shows the 'Program' screen in the ProofMaster PRO software. On the left, a list of programs is displayed, including 'Universal 1 bar' through 'Universal 10 bar', and a 'Program' entry. The 'Program' entry is highlighted with a blue circle labeled 'a'. On the right, a confirmation dialog box is shown with the text 'Delete program?' and two options: 'Yes' and 'No'. A blue circle labeled 'b' is positioned over the trash can icon, and another blue circle labeled 'c' is positioned over the 'Yes' button.

- a) Select the user program to be deleted.
 - ⇒ See [Selecting the program](#) [► Page 42].
- b) Press  to display the confirmation window for deleting the user program.
- c) Press **Yes** to delete the selected program and press **No** to cancel the operation.
 - ⇒ The deleted program disappears from the program list of the ProofMaster.

5.5.6 Viewing a program

Info

The preset programs cannot be edited.
The settings can only be viewed.

- a) Select the preset program.
⇒ See [Selecting the program](#) [Page 42].

- b) Press to display the basic configuration settings of the program.
- c) Press **Advanced parameters** to display the advanced settings of the program.
- d) Press **Basic settings** to return to the basic settings of the program.
- e) Press **Cancel** to exit the settings display.

Cancel		View program			
Title	Calibrated Leak				
Abbreviation	CL	☆			
Watch size	20-40 mm		2100 mm ³		
Pressure	bar	Test 1 +2.0	Test 2 -	Test 3 -	
Expanded settings >					
Cancel		View program / CL			
Test mode	Precise				
Measuring time	s	Test 1 AUTO	Test 2 -	Test 3 -	
Limit	µg/min	50	-	-	
Deformation min./max.	µm	-500 / 1200	-	-	
Basic settings					

5.6 ChronoMaster

5.6.1 Connecting the ChronoMaster

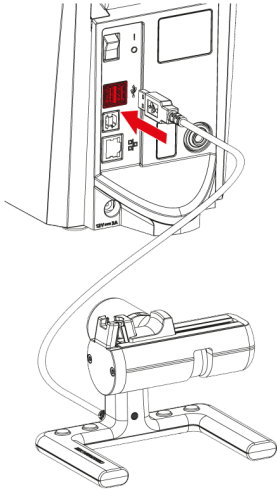

- ✓ The ProofMaster is switched on, see [Switching on the Proofmaster \[Page 36\]](#).
- a) Insert the USB connector for the ChronoMaster into an unused USB port on the ProofMaster.
 - ⇒ The **ChronoMaster** menu is displayed in the bottom left of the screen.

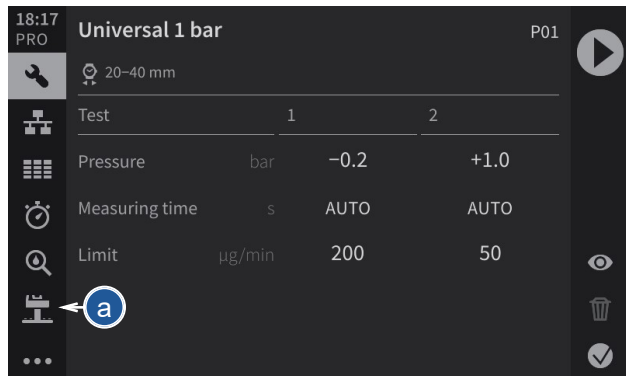

5.6.2 Starting the measurement

- ✓ The ChronoMaster is connected to the ProofMaster; see [Connecting the ChronoMaster \[Page 64\]](#)
- a) Open the clamping jaws.
- b) Insert the calibre, ensuring that the winding stem is next to the microphone.
- c) Release the clamping jaws.
- d) Press  to start a measurement.

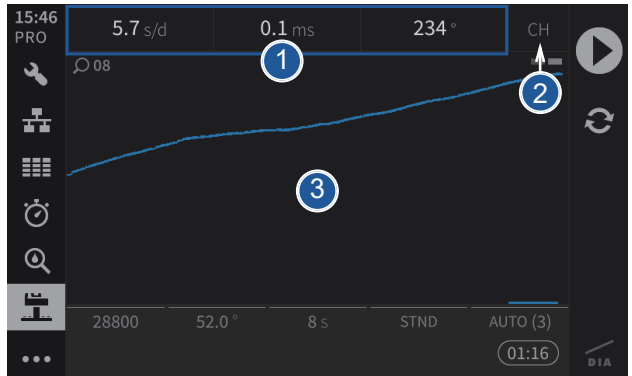

- 1 Display of the current measurement data
- 2 Measuring position of the calibre
- 3 Graphic display of the diagram

5.6.3 Configuring the measurement

- a) Press  (at the bottom left of the screen) to display the **ChronoMaster** menu.
 - ⇒ The screen for configuring the measurement appears.

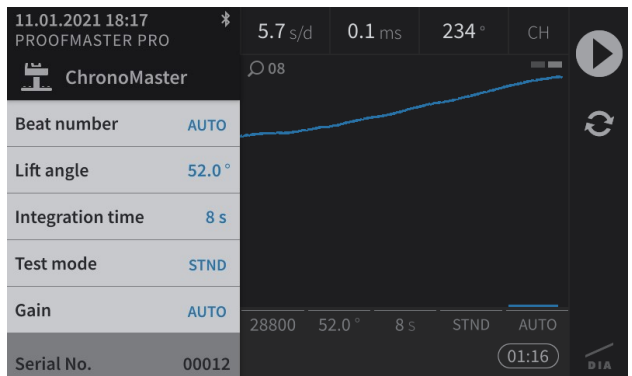

Info



The serial number of the ChronoMaster is displayed at the bottom of the menu.

Beat rate

Beat number	AUTO
-------------	------

- a) Press **Beat rate**.
 - ⇒ The selection of the test beat rate appears.
 - Auto:** Automatic determination of beat rate;
 - Freq:** Automatic determination of beat rate for rate deviation = 0 s/d;

Manual: Manual determination of beat rate. Range from 3600 to 7200 A/h;

Fixed: 18000; 19800; 21600; 25200; 28800; 36000; 72000 A/h.

- b) Press the required beat rate or press **Auto**, **Freq** or **Manual**.
 ⇒ The selected beat rate (Auto) is displayed.

Lift angle

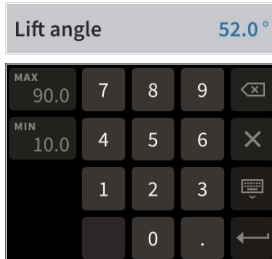

Integration time

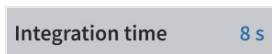

Test mode

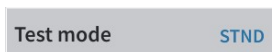

Increase

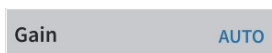

- a) Press **Lift angle**.

⇒ A number field appears.

- b) For an individual lift angle, enter the desired value between 10° and 90° and then press  to confirm the entry.

- a) Press **Integration time**.

⇒ The selection of the integration time appears. Here, you can select the integration time for which the numeric results are calculated in the diagram.

⇒ **4 A:** 4 vibrations/hour;
2 s to 60 s: Value in seconds.

- b) Press the required integration time.

- a) Press **Test mode**.

⇒ The selection of the test modes appears.

⇒ **STND:** Mode for watches with a Swiss lever escapement;
GANG: Mode for rate measurement on watches with cylinder escapement, duplex escapement or detent escapement, as well as watches making unusual noises while beating;
SPE1: Mode for watches with a coaxial escapement;
SPE2: Mode for watches with an AP escapement.

- b) Press the required test mode.

- a) Press **Increase**.

⇒ The selection of the test increase values appears.

- b) Press the required increase.

⇒ For watches with no particular measurement problems, we recommend using the **AUTO** function.

6 Maintenance

6.1 Safety during maintenance

Improper maintenance

 **CAUTION**



Risk of injury from compressed air!

If compressed air escapes uncontrolled, there is a risk of injury.

- Take care when working on the compressor or the compressed air hoses.

Prohibition



Never force the device cover to open when the device is under pressure!

Otherwise parts could be ejected.

Mandatory



Observe the documentation of the compressor manufacturer!

To avoid operating errors that can lead to damage.

Short circuit

Caution - material



Danger of material damage due to short circuit!

Damage to the insulation on the power cord or the power supply unit can result in a short circuit and damage the ProofMaster.

Prohibition



Never immerse the ProofMaster in water!

This will destroy the device.

Mandatory



Follow the obligations set out below:

Work on electronic components of the ProofMaster must only be carried out by the customer service of Witschi Electronic AG!

Failure to comply with this requirement will void the warranty.

Place the power cord so that it cannot be damaged by external influences.

This avoids the risk of damaging the power cord or power supply unit. If any of the components are damaged, disconnect the mains plug and have the power supply unit repaired.

Always disconnect the mains plug before cleaning, maintenance or repair work!

Ensure that access to the power supply is always guaranteed.

To disconnect the power supply unit from the power supply, only pull on the plug itself, never pull on the cable.

Protect live parts from moisture!

Moisture can cause a short circuit.

6.2 Maintenance schedule

Caution - material



Risk of damage to the ProofMaster due to insufficient servicing of the compressor!

Failure to service the compressor may result in contamination of the compressed air by oils harmful to the ProofMaster.

- Service the compressor as specified in the manufacturer's documentation.
- Make sure to comply with the maintenance cycles specified in the following maintenance schedule.

⇒ Non-compliance will void the warranty.

Info



The following maintenance schedule is intended for the operator of the ProofMaster.

Maintenance of the ProofMaster does not require a specialist technician.

Interval	Maintenance task	Personnel
Daily	Clean the seal with a dry microfibre cloth.	Operator
	Check that the compressed air hose is secure and in good condition.	
	Make sure that the bell cover is closed at the end of the day. See <i>Switching off the device</i> [Page 38].	
Annually (recommended)	Have the ProofMaster recalibrated. To do so, contact the point of sale. See <i>Technical support</i> [Page 7]. For calibration, the deformation sensor can be sent individually or installed with the ProofMaster. See <i>Replacing the deformation sensor</i> [Page 69].	Customer service
After 200,000 tests or every 8 years, at the latest	An inspection must be carried out on the ProofMaster. The message "Inspection required. Call Witschi service" appears when starting the ProofMaster. To do so, contact the point of sale. See <i>Technical support</i> [Page 7]. Comment The number of tests since initial commissioning can be found in the menu Settings > Info > Operating information .	Customer service

6.3 Cleaning the seal (O ring)

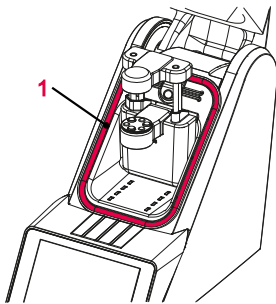

- ✓ The ProofMaster is switched off and the bell cover is open.
- a) Clean the seal **1** with a microfibre cloth.

6.4 Replacing the seal (O ring)

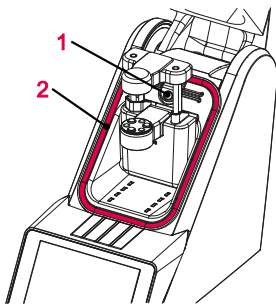

- ✓ The ProofMaster is switched off and the bell cover is open.
- a) Lift the seal **2** with the push button **1** and remove by hand.
- b) Remove dust particles and other deposits from the seal groove **2**.
- c) Insert a new seal **2**.

6.5 Replacing the deformation sensor

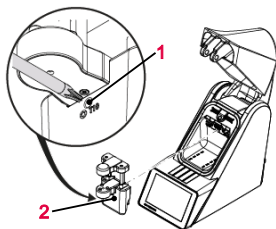

- ✓ The ProofMaster is switched off and the bell cover is open.
- a) Unscrew screw **1** with a T10 Torx screwdriver.
- b) Remove the deformation sensor **2**.
- c) Hook in the new deformation sensor **2**.
- d) Tighten screw **1**.

6.6 Software updates

With the further development of the ProofMaster, the software may also be improved under certain circumstances. In certain cases, Witschi Electronic AG may offer a new version of the software to be installed.

Info



Information on how to download the updates can be found on our website at www.witschi.com.

When you register your ProofMaster on our website, we will personally notify you of important updates.

The software for the ProofMaster can be installed as follows:

- ✓ **The ProofMaster is switched off.**
 - a) If necessary, unzip the update files for ProofMaster.
 - b) Save the unzipped files on a USB stick.
 - c) Insert the USB stick with the update files for the ProofMaster.
 - d) Switch on the ProofMaster.
 - ⇒ See Switching on the Proofmaster [Page 36].

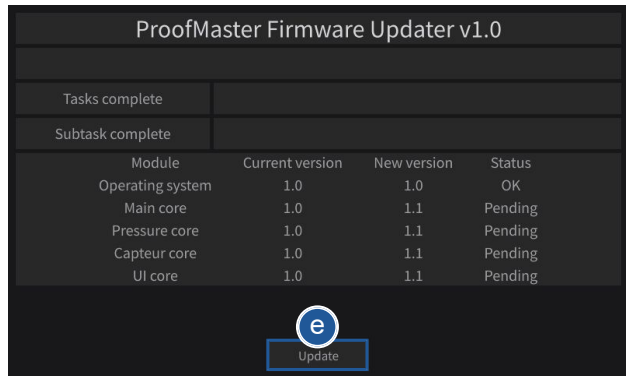
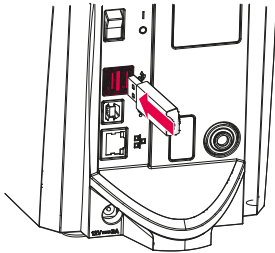

Firmware update finished!
Please turn off device and remove the USB stick!

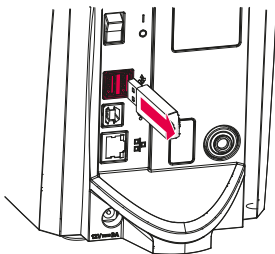

- e) Press **Update**.
- f) Wait until the screen with the following messages appears.
- g) Switch off the ProofMaster.
- h) Remove the USB stick.
 - ⇒ The ProofMaster update has been installed successfully.

6.7 Accessories and spare parts

Ordering spare parts

To order accessories or spare parts, please contact *Technical support* [[Page 7](#)].

Your nearest point of sale can be found on our website www.witschi.com.

Compressed air

Accessories	Item no.
JunAir 6–10 compressor, 10 l with automatic drainage	97.91.103 (230 V~) 97.91.104 (120 V~)
Compressed air connection with hose (2 metres)	31.10.311
Compressed air hose (by the metre)	KA05-1100P06-01
JUN-AIR special oil 0.5 litres	PA04-SJ27-OIL
T-compressed air connection	KA03-3104-06-00
Exhaust air kit (without silencer)	31.24.050
Silencer incl. exhaust air kit Noise reduction up to 40 dB(A) Connection for up to 4 ProofMaster	31.24.051

Printing

Accessories	Item no.
Thermal printer	JB01-SLK-TE25-S
Bluetooth Set II to Printer (Plug-in unit + dongle)	95.1511
USB Bluetooth dongle (for additional ProofMaster devices)	JB15-BT851-US
Spare thermal paper roll for JB01-SLK-TE25-S	JB01-MM60-740RS

Software

Accessories	Item no.
WiCoTRACE 3 SERVER	64.6110
WiCoTRACE 3 SERVER+	64.6210

Power supply unit

Accessories	Item no.
Power supply unit 100–240 VAC/12 VDC/36 W	JA01-PSD40E120K3

Accessories

Accessories	Item no.
Seal (O ring) of the bell cover	NA04-OR138x05
Support for small watches	31.24.702
Protective cover	31.24.04.30
USB cable, 1.8 metres	JB03-11.02.8818
Bar code reader	JB15-GD4520-BKK1S

7 Settings

7.1 Quick settings menu

Opening the quick settings

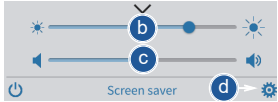
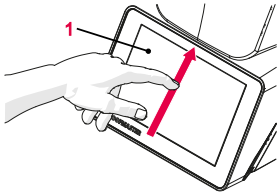

Closing the quick settings

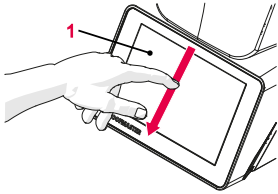

✓ The ProofMaster is switched on, see [Switching on the Proofmaster](#) [▶ Page 36].

a) Swipe the touchscreen **1** with your finger in the direction of the arrow.

⇒ The quick settings appear.

b) Move the cursor left to decrease the brightness and right to increase the brightness.

c) Move the cursor left to decrease the volume and right to increase the volume.

d) Press  to open the Settings menu.

a) Swipe the touchscreen **1** with your finger in the direction of the arrow.

⇒ The settings window is closed.

Tip



Additional display and audio settings can be made.

See [Display and audio settings](#) [▶ Page 76].

7.2 Settings

The settings of the ProofMaster can be changed in the settings. Proceed as follows to access the settings:

The ProofMaster offers quick access – see the *Quick settings menu* [▶ Page 72] – and conventional access to the configuration menu settings.

Info



The functions of the keys are described in the *Menus and operating buttons* [▶ Page 57] section.



a) Press (at the bottom left of the screen) to display the expanded menu.

b) Press to access the settings.

⇒ The settings menu is displayed.

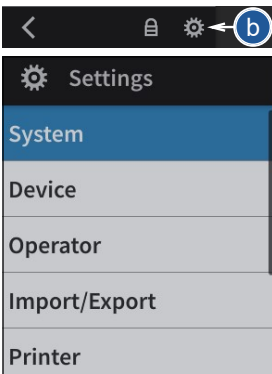

7.3 System

7.3.1 Language selection

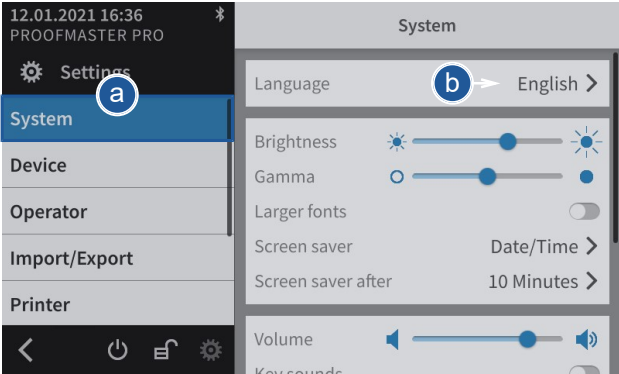

The screenshot shows the Settings application on a device. The left sidebar lists various settings categories: Settings, System (highlighted in blue with a circled 'a'), Device, Operator, Import/Export, and Printer. The right pane displays the 'System' settings, with 'Language' selected (circled 'b') and set to 'English'. Below 'Language' are sliders for Brightness and Gamma, and toggle switches for Larger fonts, Screen saver, and Screen saver after. At the bottom, there is a Volume slider and a Key sounds option.

Deutsch	
English	✓
Français	
Italiano	
Español	

a) Select **System** from the list.
⇒ **System** is highlighted in blue and the right window displays the system options.

b) Tap the display language to open the selection window.

c) Select the desired display language from the list.

7.3.2 Screen saver

If the automatic screen saver function of the ProofMaster is activated, the bell cover closes after the "Enable after" time set on the ProofMaster and the screen saver is displayed.

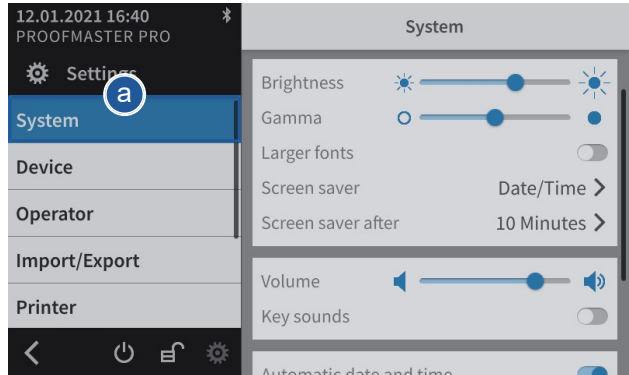

- a) Select **System** from the list.
 - ⇒ **System** is highlighted in blue and the right window displays the system options.
- b) Configure the automatic screen saver according to your needs.
 - ⇒ See the details below for the settings of each option.

Selecting the screen saver

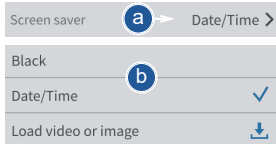

- a) Open the screen saver selection by tapping the current selection.
- b) Choose between a black screen saver and a screen saver with date and time. Alternatively, it is possible to import a screen saver.

Importing a screen saver

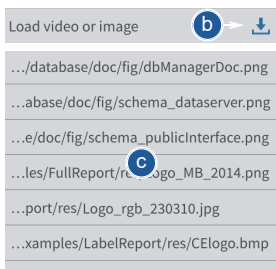

- a) Insert a USB stick with the desired screen saver into the ProofMaster.
- b) Press to display the pictures and videos on the USB stick.
- c) Select the desired picture or video from the list.
 - ⇒ The display returns to the screen saver selection screen.
 - ⇒ The selected image or video appears in the screen saver selection list.

Screen saver	Supported formats	Optimum resolution	Description
Images	PNG, BMP, JPG, JPEG	800x480	Images with other resolutions must be resized.

Screen saver	Supported formats	Optimum resolution	Description
Videos	MP4	800x480	Videos in another aspect ratio are displayed with a black bar. It may not be possible to play high-resolution videos.

Deleting a screen saver



Enabling automatic standby of the ProofMaster.

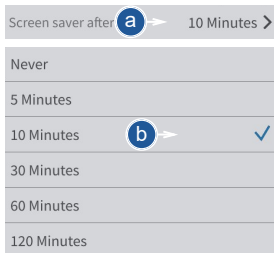

Info

Only imported screen savers can be deleted.
 The black screen saver and the screen saver with date and time are system configurations.

- a) Select the imported screen saver to be deleted.
- b) Press to delete the desired imported screen saver.
- a) Enable or disable the screen saver display.

- b) Select the desired time.

7.3.3 Display and audio settings

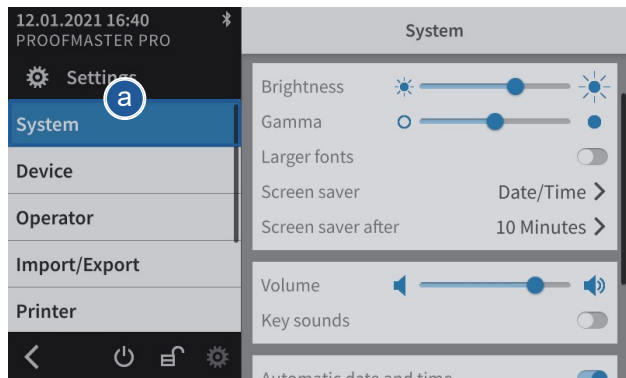

- a) Select **System** from the list.
 - ⇒ **System** is highlighted in blue and the right window displays the system options.
- b) Configure the display and audio settings as needed.
 - ⇒ See the details below for the settings of each option.

Brightness



- a) Move the cursor left to decrease the brightness and right to increase the brightness.

Contrast



- a) Move the cursor left to decrease the contrast and right to increase the contrast.

Font sizes

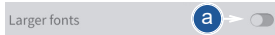

- a) Enable or disable the large font display.
 - ⇒ The button is blue when the function is enabled and grey when it is not.

Volume level



- a) Move the cursor left to decrease the volume level and right to increase the volume level.

Enabling the button sound

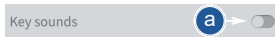

- a) Enable or disable the button sound.
 - ⇒ The button is blue when the function is enabled and grey when it is not.

7.3.4 Date & time

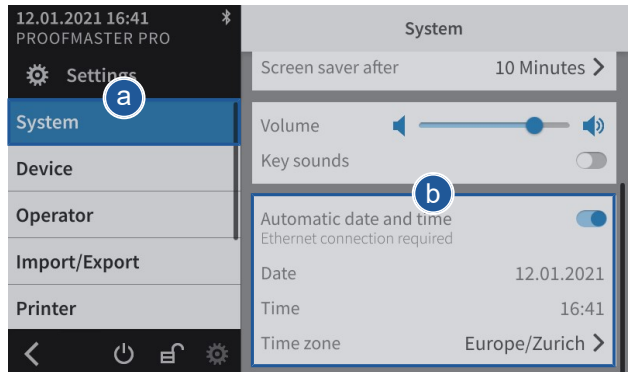

- a) Select **System** from the list.
 - ⇒ **System** is highlighted in blue and the right window displays the system options.
- b) Set the date and time.
 - ⇒ See the details below for the settings of each option.

Automatically setting the date and time

When this function is enabled, the date and time of the unit are set automatically.

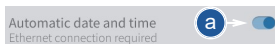

- a) Enable or disable the automatic setting of the date and time.
 - ⇒ The button is blue when the function is enabled and grey when it is not.

Mandatory



The ProofMaster must have an Internet connection!

Setting the date manually

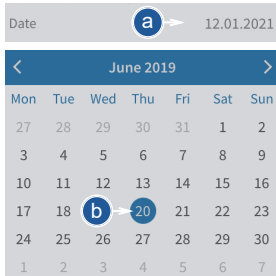

Setting the time manually

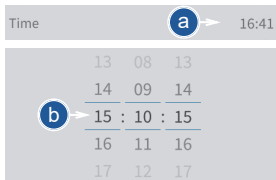

Setting the time zone manually

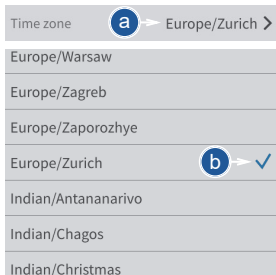

✓ The automatic setting of the date and time is disabled.

- a) Open the date selection by tapping the displayed date.
- b) Select the desired date in the calendar.

✓ The automatic setting of the date and time is disabled.

- a) Open the time selection by tapping the displayed time.
- b) Select the desired time.

✓ The automatic setting of the date and time is disabled.

- a) Open the time zone selection by tapping the displayed time zone.
- b) Select the desired time zone.

7.4 Device

7.4.1 Opening speed of the bell cover

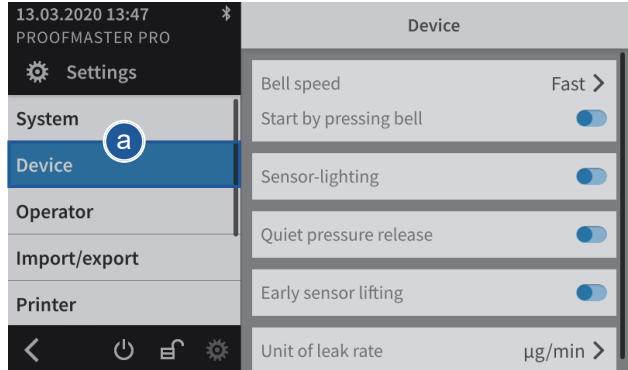

- a) Select **Device** from the list.
 ⇒ **Device** is highlighted in blue and the right window displays the device options.
- b) Open the bell cover speed selection by tapping the current selection.
- c) Select the desired bell cover speed.

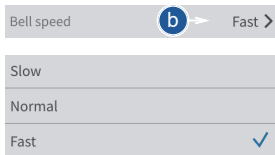

7.4.2 Start by pressing the bell cover

Using this function, a measurement can be started by pressing the bell cover.

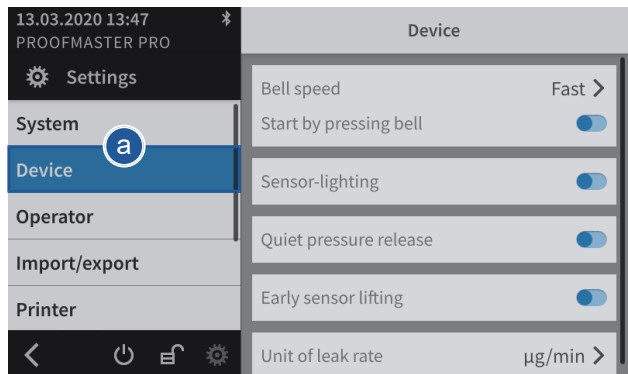

- a) Select **Device** from the list.

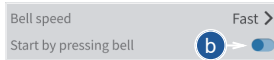

⇒ **Device** is highlighted in blue and the right window displays the device options.

b) Activate or deactivate the function **Start by pressing the bell cover**.

⇒ The button is blue when the function is enabled and grey when it is not.

7.4.3 Sensor lighting

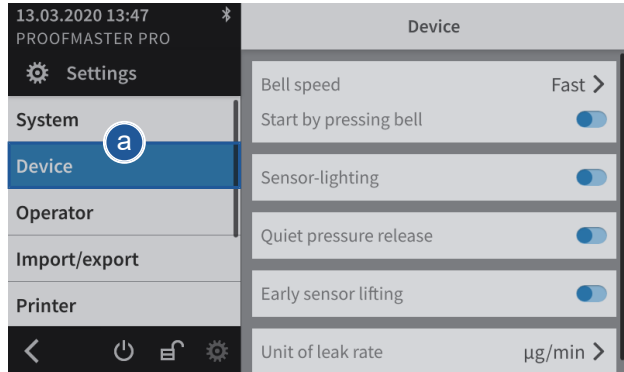

a) Select **Device** from the list.

⇒ **Device** is highlighted in blue and the right window displays the device options.

b) Enable or disable the **sensor lighting**.

⇒ The button is blue when the function is enabled and grey when it is not.



7.4.4 Quiet pressure release

This setting allows the test pressure to be released more slowly from the test chamber.

This reduces the noise emission but increases the test time.

For a test at 10 bar, the sound level is reduced from 75 dB(A) to 68 dB(A) and the discharge can be increased by 15 seconds.

7.4.5 Unit of leak rate

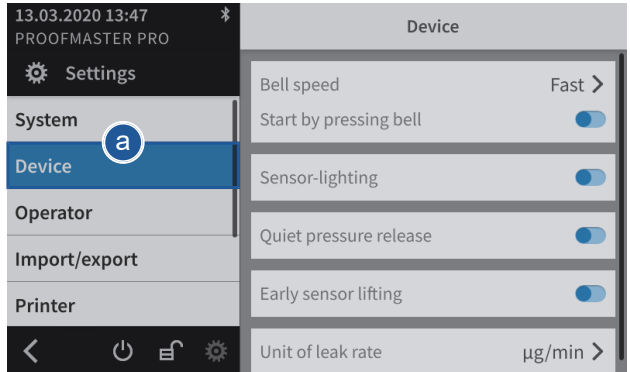

- a) Select **Device** from the list.
 ⇒ **Device** is highlighted in blue and the right window displays the device options.
- b) Open the unit selection for the leak rate by tapping the current selection.
- c) Select the desired leak rate unit.

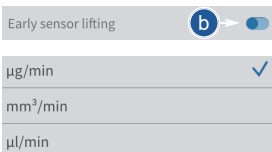

7.5 User management (ProofMaster PRO)

Info



This function is available in the ProofMaster PRO software version.

7.5.1 Administrator and user modes

The device has two modes, administrator mode and user mode.

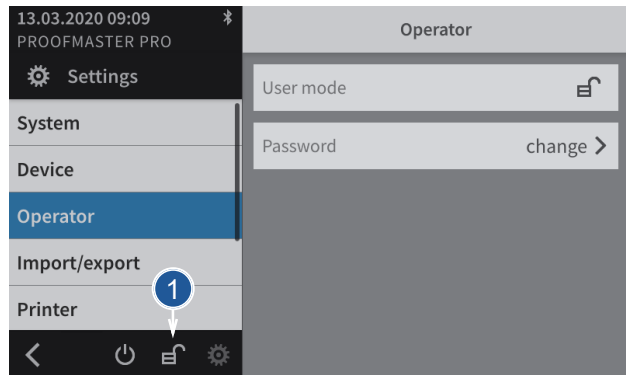

Administrator mode

Administrator mode enables access to all device settings, and the symbol  (1) is displayed on the screen.

User mode

User mode deactivates or removes the following functions/settings, and the symbol  (1) is displayed on the screen.

Programs menu

- Creating a new program
- Editing a program
- Deleting a program

Result menu

- Deleting results

Settings menu

- Device
- Import/export
- Printer
- Network
- WiCoTRACE
- Locking time settings on the system

7.5.2 Activating user mode

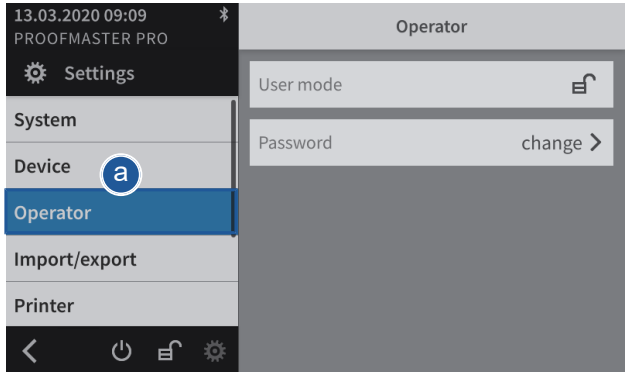

- a) Select **User** from the list.
⇒ **User** is highlighted in blue and the right window displays the user options.

- b) Activate user mode by pressing .

- c) Press **OK** to confirm.

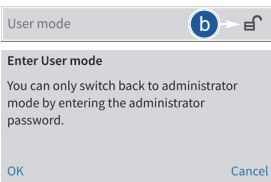

7.5.3 Activating administrator mode

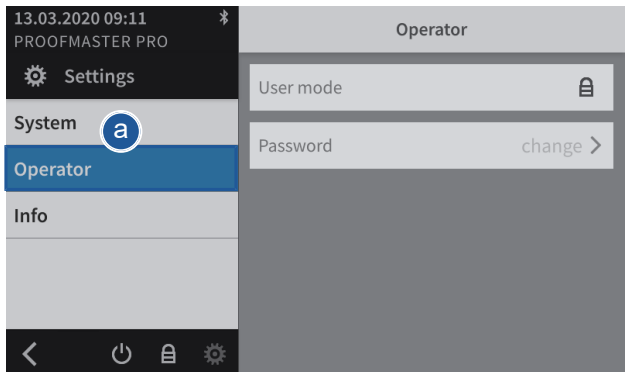

- a) Select **User** from the list.
⇒ **User** is highlighted in blue and the right window displays the user options.

- b) Activate administrator mode by pressing .



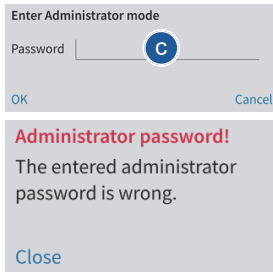

- c) Enter the password.
 - ⇒ The default password is **witschi**.
- d) Press **OK** to confirm.

⇒ In the event of an error, an information window appears.

7.5.4 Changing the password

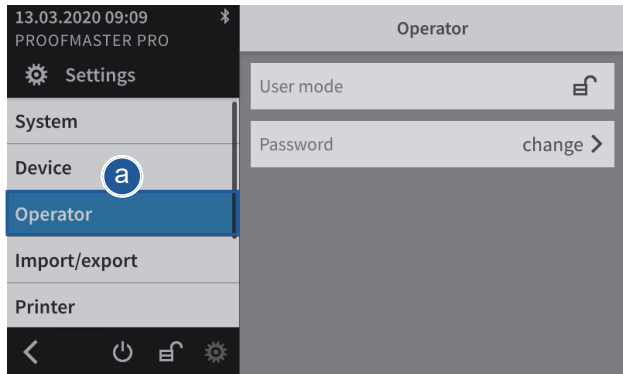

- a) Select **User** from the list.
 - ⇒ **User** is highlighted in blue and the right window displays the user options.
- b) Open the window for changing the password by pressing **Change**.
- c) Enter the current password.
 - ⇒ The default password is **witschi**.
- d) Enter the new password.
- e) Confirm the new password.
- f) Press **OK** to confirm.

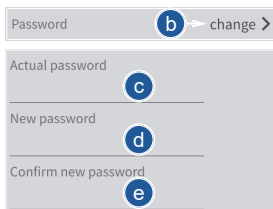

7.6 Import/export

7.6.1 Importing/exporting settings

The ProofMaster allows you to import and export these settings using a USB stick. This means settings created can be transferred to other devices.

Exporting

- a) Insert the USB stick on which the settings are to be stored in the ProofMaster.

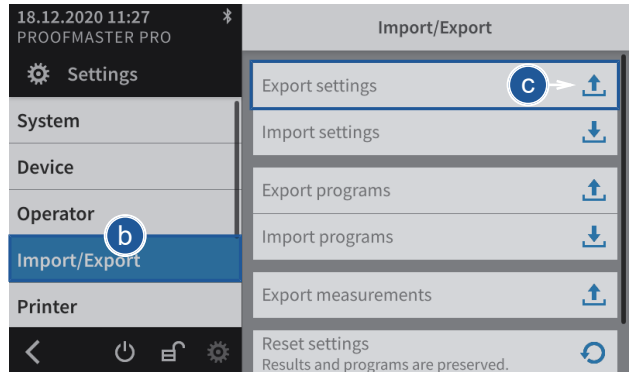
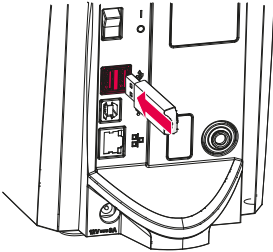

- b) Select **Import/export** from the list.
 - ⇒ **Import/export** is highlighted in blue and the right window displays the import/export options.
- c) Press  **Export settings**.
 - ⇒ A window appears confirming the successful completion of the settings export.
 - ⇒ The settings of the ProofMaster were exported to the USB stick in the **config.json** file.
- d) Remove the USB stick.

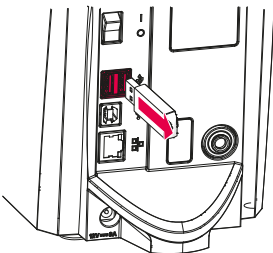

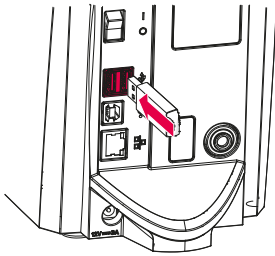

Importing

- a) Insert a USB stick with the settings into the ProofMaster.

Mandatory



The settings to be imported must be combined in a file with the file name config.json. The file is created by carrying out an export.

Otherwise the ProofMaster will not find the settings to import.

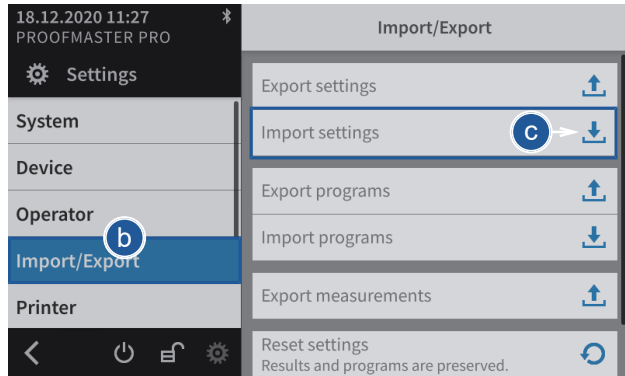

- b) Select **Import/export** from the list.
 - ⇒ **Import/export** is highlighted in blue and the right window displays the import/export options.
- c) Press **Import settings**.
 - ⇒ An information and confirmation window appears.
- d) Press **OK** to confirm.
 - ⇒ The settings of the ProofMaster have been replaced by the settings imported from the USB stick.
 - ⇒ The ProofMaster restarts.
- e) Remove the USB stick.

Import settings

All settings are overwritten. Results and programs are retained. The instrument is restarted.

OK

Cancel

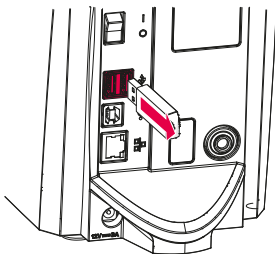

7.6.2 Importing/exporting programs (ProofMaster PRO)

Info



This function is available in the ProofMaster PRO software version.

The ProofMaster allows the import and export of programs within the network or using a USB stick.

Export with USB stick

a) Insert the USB stick on which the programs are to be stored in the ProofMaster.

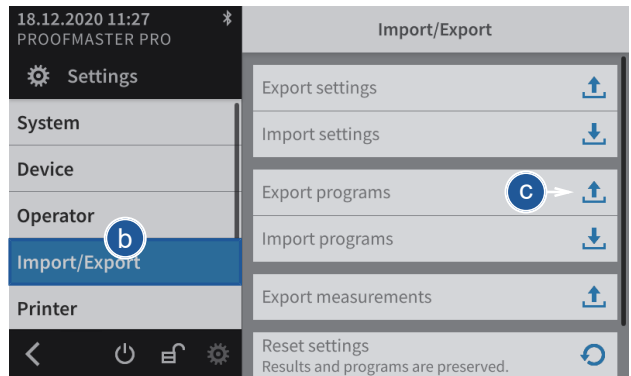
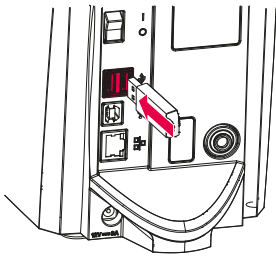

b) Select **Import/export** from the list.

⇒ **Import/export** is highlighted in blue and the right window displays the import/export options.

c) Press **Export programs**.

⇒ A window appears confirming the successful completion of the programs export.

⇒ The programs of the ProofMaster were exported to the USB stick in the **programs.json** file.

d) Remove the USB stick from the ProofMaster.

Export programs

Programs exported successfully.

OK

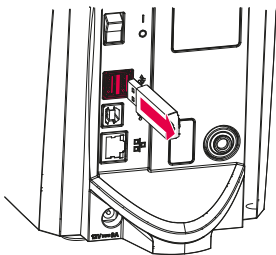

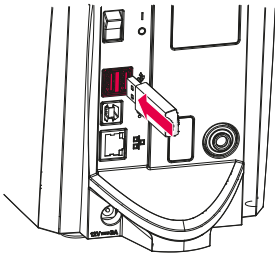

Import with USB stick

- a) Insert a USB stick with the programs into the ProofMaster.

Mandatory



The programs to be imported must be combined in a file with the file name `programs.json`. The file is created by carrying out an export.

Otherwise the ProofMaster will not find the files to import.

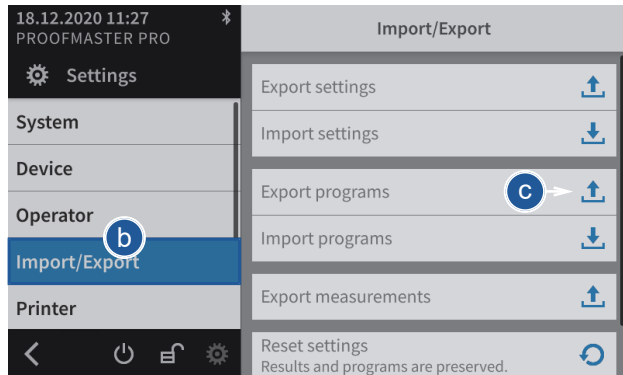

- b) Select **Import/export** from the list.
 ⇒ **Import/export** is highlighted in blue and the right window displays the import/export options.
- c) Press **Import programs**.
 ⇒ An information and confirmation window appears.
- d) Press **OK** to confirm.
 ⇒ The home page is shown.
 ⇒ The programs of the ProofMaster have been replaced by the programs imported from the USB stick.
 ⇒ The ProofMaster restarts.
- e) Remove the USB stick from the ProofMaster.

Import programs

All programs are overwritten. The device is restarted.

OK

Cancel

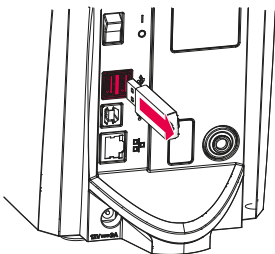

7.6.3 Exporting measurements

Info



This function is intended for analysis by Witschi Electronic AG Customer Service.

The ProofMaster allows you to export measurement data using a USB stick. This enables the measurements that have been performed to be analysed by Witschi Electronic AG.

Exporting

- a) Insert the USB stick on which the measurement data is to be stored in the ProofMaster.

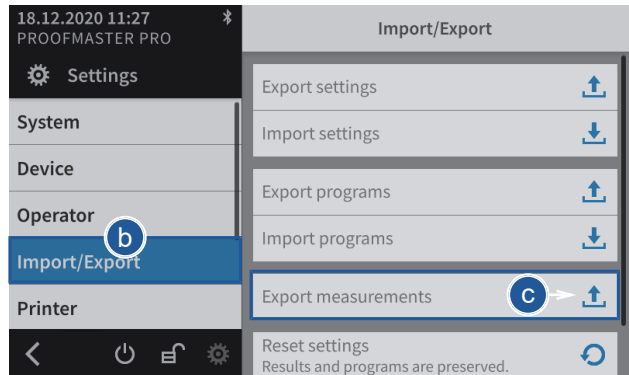
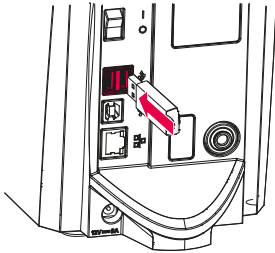

- b) Select **Import/export** from the list.
 - ⇒ **Import/export** is highlighted in blue and the right window displays the import/export options.
- c) Press **Export measurements**.
 - ⇒ A window appears confirming the successful completion of the measurement data export.
 - ⇒ The measurement data of the ProofMaster has been exported to the USB stick in the **mesures.json** file.

Export measurements

Measurements exported successfully.

OK

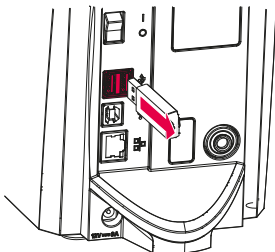

- d) Remove the USB stick.

7.6.4 Resetting the device settings

This process restores the factory settings of the ProofMaster. The programs and test results are retained.

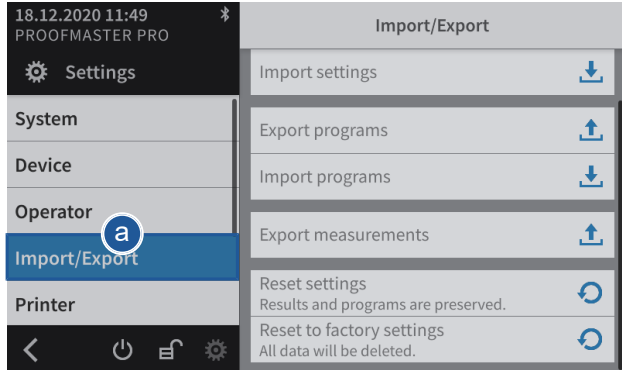

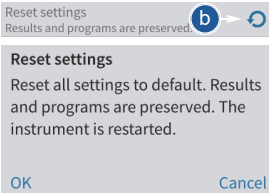

- a) Select **Import/export** from the list.
 - ⇒ **Import/export** is highlighted in blue and the right window displays the import, export and recovery options.
- b) Press  to reset the settings of the ProofMaster.
 - ⇒ A confirmation window appears.
- c) Press **OK** to confirm.
 - ⇒ The ProofMaster restarts.

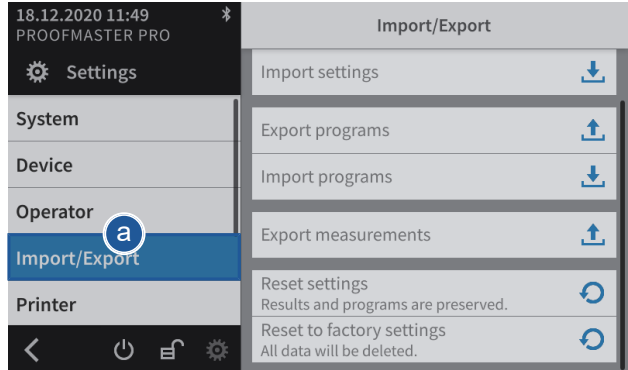

7.6.5 Restoring factory settings

This process restores the factory settings of the ProofMaster and deletes all program data, measurement results, etc. on the device.



- a) Select **Import/export** from the list.
 - ⇒ **Import/export** is highlighted in blue and the right window displays the import, export and recovery options.
 - ⇒ Press  to restore the factory settings of the ProofMaster.
 - ⇒ A confirmation window appears.
- b) Press **OK** to confirm.
 - ⇒ The ProofMaster restarts.

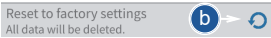

Reset to factory settings

Reset your device to factory settings. This deletes all data including programs and results. The instrument is restarted.

OK
Cancel

7.7 Printer

7.7.1 Configuring the printer

The configuration of the thermal printer is carried out on the ProofMaster.

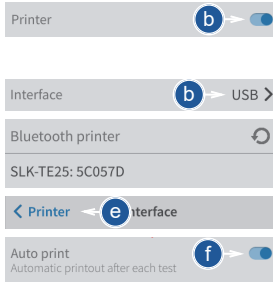
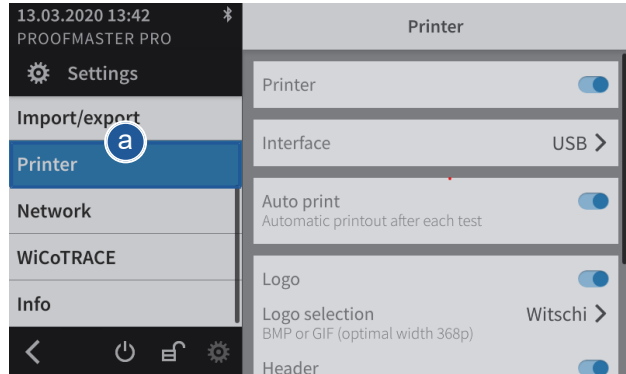

- a) Select **Printer** from the list.
 - ⇒ **Printer** is highlighted in blue and the right window displays the device options.
- b) Enable the printer.
 - ⇒ The button is blue when the function is enabled and grey when it is not.
- c) Open the user interface display by tapping the current selection.
- d) Select the connection type.
 - ⇒ In the following example, Bluetooth.
- e) Press < **Printer** to save and return to the previous screen.
- f) If necessary, enable automatic printing.
 - ⇒ The button is blue when the function is enabled and grey when it is not.
- g) If necessary, configure the label.
 - ⇒ See [Configuring the label](#) [▶ Page 93].

7.7.2 Configuring the label

Configurable areas

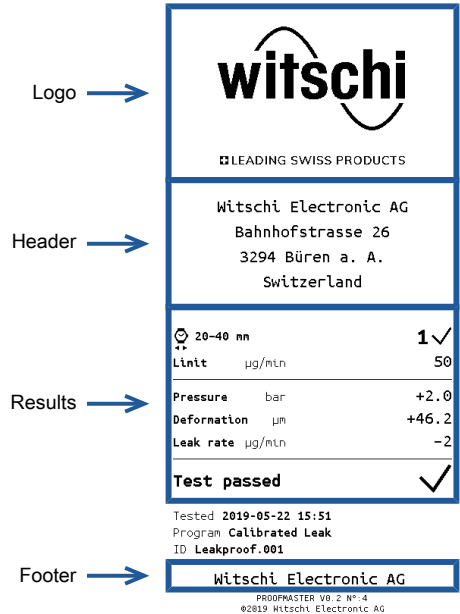

The figure above shows the different configurable areas of the label.

- ✓ **Printer configured.**

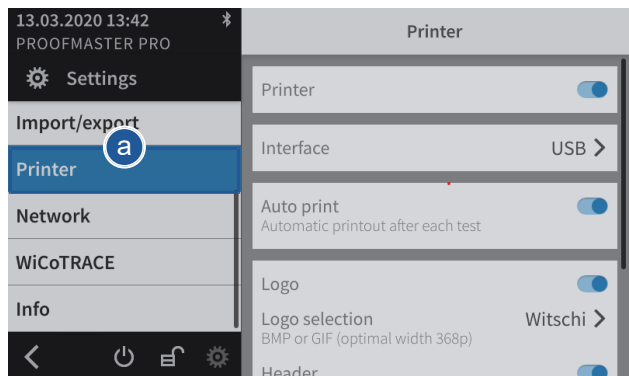

- Select **Printer** from the list.
 - ⇒ **Printer** is highlighted in blue and the right window displays the printer options.
- Configure the label as required.
 - ⇒ See the details below for the settings of each option.

Printing the logo

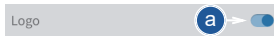

- a) Enable or disable the printing of the logo.
 - ⇒ The button is blue when the function is enabled and grey when it is not.

Selecting the logo

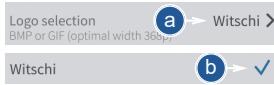

- a) Open the logo selection by tapping the name of the displayed logo.

- b) Select the desired logo from the list.
 - ⇒ In the above example, **Witschi**.
 - ⇒ The **Witschi** logo is printed on the label.

Importing the logo

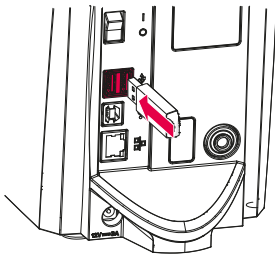

- a) Open the logo selection by tapping the name of the displayed logo.

- b) Insert a USB stick with the desired logo into the ProofMaster (BPM or GIF, optimal width: 368 p).

- c) Press  **Load new logo**.
- d) Select the desired logo from the list.
 - ⇒ All image files (png, jpg, bmp, tec etc.) on the USB stick appear in the list.
 - ⇒ In the above example, selection of **CElogo**.
 - ⇒ The **CElogo** is now in the list and selected.
 - ⇒ The **CElogo** logo is printed on the label.

Printing the header

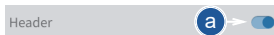

- a) Enable or disable the printing of the header.
 - ⇒ The button is blue when the function is enabled and grey when it is not.

Configuring the header



- a) Open the header configuration by tapping the beginning of the displayed header.

- b) Tap on the text area to open the alphanumeric keypad.



Selecting the results display

- c) Enter the header using the alphanumeric keypad.
 - ⇒ 4 lines with maximum 30 characters.
 - ⇒ The entered header is printed on the label.

The measurement result can be displayed in numeric or reduced form. See examples below.

Numeric format		Reduced format	
OK	Not OK	OK	Not OK
<p>Witschi BLEADING SWISS PRODUCTS Witschi Electronic AG Bahnhofstrasse 26 3294 Büren s. A. Switzerland</p> <p>20-40 mm 1 ✓ Leak rate 19/min 50</p> <p>Pressure bar +2.0 Deformation µm +46.2 Leak rate 19/min -2</p> <p>Test passed ✓</p> <p>Tested 2019-05-22 15:51 Program Calibrated Leak (0) LeakProof-001</p> <p>PROGRAMMIERER UN 2 W.-D. 4030-00000-00000000-01</p>	<p>Witschi BLEADING SWISS PRODUCTS Witschi Electronic AG Bahnhofstrasse 26 3294 Büren s. A. Switzerland</p> <p>20-40 mm 1 ✗ Leak rate 19/min 50</p> <p>Pressure bar +2.0 Deformation µm +33.5 Leak rate 19/min +208</p> <p>Test failed ✗</p> <p>Tested 2019-05-22 15:56 Program Calibrated Leak (0) 200µg/mIn-001</p> <p>PROGRAMMIERER UN 2 W.-D. 4030-00000-00000000-01</p>	<p>Witschi BLEADING SWISS PRODUCTS Witschi Electronic AG Bahnhofstrasse 26 3294 Büren s. A. Switzerland</p> <p>20-40 mm 1 ✓ Leak rate 19/min 50</p> <p>Pressure bar +2.0 ✓</p> <p>Tested 2019-05-22 15:51 Program Calibrated Leak (0) LeakProof-001</p> <p>PROGRAMMIERER UN 2 W.-D. 4030-00000-00000000-01</p>	<p>Witschi BLEADING SWISS PRODUCTS Witschi Electronic AG Bahnhofstrasse 26 3294 Büren s. A. Switzerland</p> <p>20-40 mm 1 ✗ Leak rate 19/min 50</p> <p>Pressure bar +2.0 ✗</p> <p>Tested 2019-05-22 15:58 Program Calibrated Leak (0) 200µg/mIn-001</p> <p>PROGRAMMIERER UN 2 W.-D. 4030-00000-00000000-01</p>

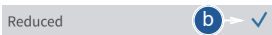

- a) Open the results display by tapping the displayed selection.

- b) Select the desired display type.
 - ⇒ In the above example, Reduced.

Printing the footer



- a) Enable or disable the printing of the footer.
 - ⇒ The button is blue when the function is enabled and grey when it is not.

Configuring the footer

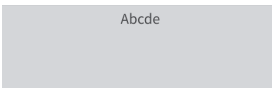
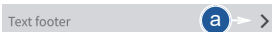

- a) Open the footer configuration by tapping the beginning of the displayed footer.
 - ⇒ In the following example, no text is entered in the footer.

- b) Tap on the text area to open the alphanumeric keypad.

- c) Enter the footer using the alphanumeric keypad.
 - ⇒ 4 lines with maximum 30 characters.
 - ⇒ The entered footer is printed on the label.

7.8 Network

The connection option allows automatic configuration of the ProofMaster with the help of a server.

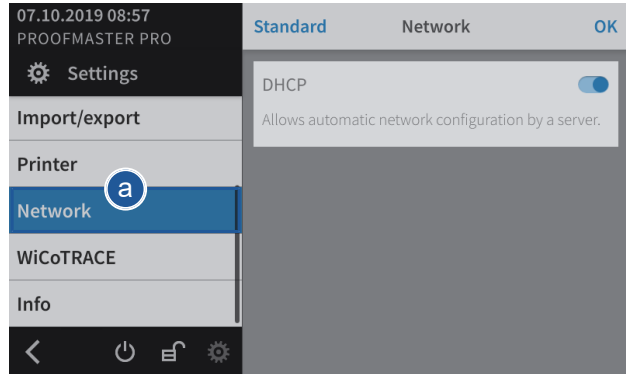

- a) Select **Network** from the list.
 - ⇒ **Network** is highlighted in blue and the right window displays the network options.
- b) Enable or disable the network.
 - ⇒ The button is blue when the function is enabled and grey when it is not.

7.9 WiCoTRACE

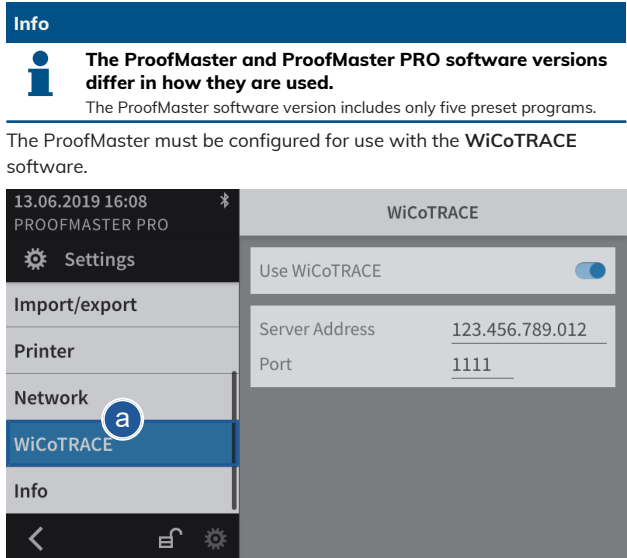

- a) Select **WiCoTRACE** from the list.
 - ⇒ **WiCoTRACE** is highlighted in blue and the right window displays the options for **WiCoTRACE**.
- b) Enable or disable the use of **WiCoTRACE**.
 - ⇒ The button is blue when the function is enabled and grey when it is not.
- c) Enter the IP address of the server where **WiCoTRACE** is located.
- d) Enter the port of the server where **WiCoTRACE** is located.
 - ⇒ The ProofMaster is connected to the **WiCoTRACE** software.

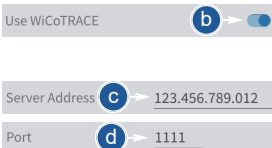

7.10 System information

This menu displays the following information:

- Serial numbers
- IP address
- Versions of the different systems and programs
- Information on device operation (cycle counter, measuring counter, etc.)
- Last calibration
- Legal information (licenses)

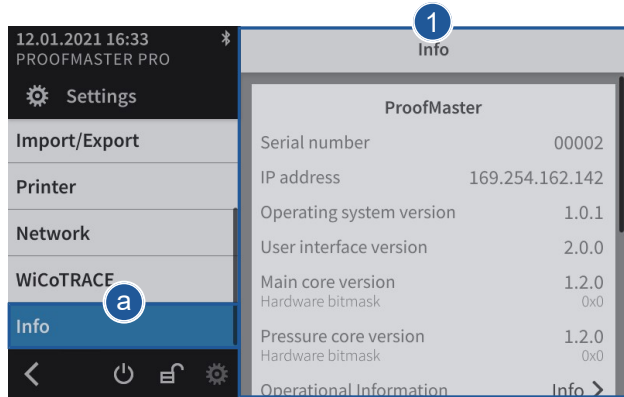

a) Select **Info** from the list.

⇒ **Info** is highlighted in blue and the right window displays the system information **1**.

Tip



Use the scroll bar on the right side of the window to display non-visible information.

8 Troubleshooting

8.1 Error messages

Info



Error messages appear in the event of a malfunction in the device.

The following table provides information about the possible causes of an error message and information on how to correct it.

The most important faults are described below. Contact customer service if the fault persists after all possible repair options have been carried out.

Error message	Cause	Remedy
No or too low inlet pressure available! Test pressure cannot be reached.	Inlet pressure is too low.	Check the compressor's output pressure.
	The maximum vacuum that can be generated depends on the current air pressure (location, altitude above sea level).	The output pressure must be at least 1 bar higher than the chosen test pressure.
No test specimen detected! Deformation sensor has reached lower limit. It is likely that no test specimen has been inserted.	No test specimen was inserted.	Insert test specimen.
Bell cover blocked! Please check if free movement is possible.	Object jammed.	Remove object.
Hook blocked! Please check if free movement is possible.	Object jammed.	Remove object.
Deformation sensor blocked! Please check if free movement is possible.	Object jammed.	Remove object.
Positive or negative pressure in test chamber! Chamber cannot be opened or closed.	Pressure could not be released from the chamber. Deformation sensor was not correctly fitted.	If bell cover is open: Check whether the deformation sensor is correctly fitted.
		If bell cover is closed: Release the pressure manually and open the bell cover (See <i>Opening the bell cover in an emergency</i> [Page 101]).
Communication error! Check whether the deformation sensor is fitted.	Deformation sensor was not correctly fitted.	Check whether the deformation sensor has been correctly fitted.

Error message	Cause	Remedy
No printer found! Check printer and USB port.	Printer not switched on. USB cable defective or not correctly connected.	Check printer and USB cable.
WiCoTRACE (SMX service) error! No connection to the SMX service could be established.	Ethernet cable defective or not correctly connected.	Check Ethernet cable.
	WiCoTRACE configuration not set up correctly.	Check if the SMX service is started correctly by WiCoTRACE. Check WiCoTRACE configuration.
WiCoTRACE (SMX service) error! No response received from SMX service.	Ethernet cable defective or not correctly connected.	Check Ethernet cable.
	WiCoTRACE configuration not set up correctly.	Check if the SMX service is started correctly by WiCoTRACE. Check WiCoTRACE configuration.
Vibration detected The measurement result is unreliable. Resume measurement?	A vibration was detected during the test.	Install the test device at a suitable, vibration-free location.
	Vibrations could distort the measurement result.	

8.2 Malfunctions

Description of malfunction	Cause	Solution
Incorrect test result	The watch is not positioned correctly.	Reposition the watch. See <i>Positioning the watch</i> [Page 44].
	Adhesive or protective foil on the watch case.	Remove the adhesive or protective foil.
	The watch is not at ambient temperature.	Wait until the watch has warmed up or cooled down. Repeat the test.
	More and more incorrect test results occur. The device is not properly calibrated.	Have the device calibrated by customer service. See <i>Technical support</i> [Page 7].
Test results are not being printed	There is no more paper in the printer.	Insert a new paper roll. Please refer to the manufacturer's documentation for more information.
	Automatic printing of test results is not enabled.	Enable automatic printing of test results. See <i>Configuring the printer</i> [Page 92].

8.3 Opening the bell cover in an emergency

The bell cover can be opened manually in the following cases:

- The test was cancelled. The watch has to be removed from the test chamber.
- The test chamber does not open automatically, for example after a power failure.

Mandatory



Wear safety goggles during the entire bell cover opening process!

- Switch off the compressor as specified in the manufacturer's documentation.
- Release the air from the compressed air hose of the compressor.
- Switch off the ProofMaster.
 - ⇒ The remaining pressure in the test chamber escapes.
 - ⇒ See [Switching off the device](#) [▶ Page 38].
- If the residual pressure does not escape from the test chamber, carefully insert a thin, rounded object between the bell cover **1** and the bottom **2**.

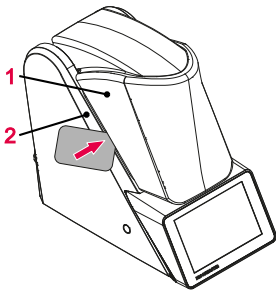

Prohibition



Do not use a pointed object to open the bell cover!

Pointed objects can lead to material damage (seal) or scratches.

- Use objects with rounded corners, e.g. playing cards.

⇒ The pressure is released.

- Wait until the pressure has completely dissipated.
- Remove the cap **3**.
- Insert a size 4 or 5 **5** screwdriver into hole **4** and turn clockwise to release the bell cover **1**.
- Open the bell cover **1**.

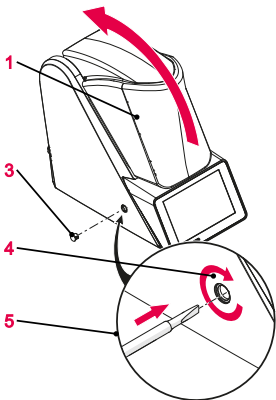

9 Decommissioning and disposal

Decommissioning

CAUTION



Risk of injury from compressed air!

If compressed air escapes uncontrolled, there is a risk of injury.

- Take care when working on the compressor or the compressed air hoses.

Prohibition



Never force the device cover to open when the device is under pressure!

Otherwise parts could be ejected.

✓ The ProofMaster is switched off.

- Switch off the compressor as specified in the manufacturer's documentation.
- Disconnect the compressor from the compressed air hose as specified in the manufacturer's documentation.
- Press the ring **1** and disconnect the compressed air hose **2** from the ProofMaster **3**.
- Switch off the other used accessories properly.
- Pull out all cables (USB/Ethernet).
- Disconnect the power supply unit connection from the local mains network.
- Disconnect the power supply unit connection from the power supply connection of the ProofMaster **4**.
 - ⇒ The ProofMaster is non-operational.

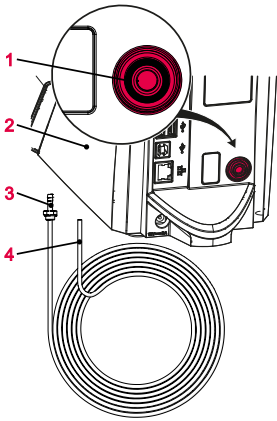

Disposal

If no return or disposal agreement has been made, return the device to a recycling point.

Caution - environmental



Improper disposal poses an environmental hazard!

Improper disposal can result in environmental pollution.

- Always contact a specially approved body for disposal of the device.
- If there is any uncertainty, contact the local government or a company specialising in waste management to find out about the conditions for environmentally sound disposal.

Electrical and electronic components



Electrical and electronic components must not be disposed of with household waste, but must be disposed of at a recycling centre or a specialised company.

10 Data sheet

Mass and weight

Designation	Value	Unit
Weight	5.8	kg
Width	149	mm
Height when bell cover is closed	243	mm
Height when bell cover is opened	370	mm
Depth	305	mm

Performance data

Designation	Value	Unit
Vacuum range	-0.1 to -0.8	bar
Pressure range	0.1 to 10	bar
Accuracy of test pressure	± 80	mbar

Mains supply connection values

Designation	Value	Unit
Mains voltage	100 to 240	VAC
Mains frequency	50/60	Hz

Power supply unit output values

Designation	Value	Unit
Voltage	12	VDC
Maximum current consumption	3.0	A
Maximum power consumption	36	W

Compressed air connection

Designation	Value	Unit
Maximum supply pressure	12	bar
Supply pressure for operation of the device with maximum power	11	bar
Compressed air consumption per pressure test	10	l/test
Compressed air consumption per vacuum test	40	l/test
Compressed air quality	Dry and dust-free	

Measuring characteristics

Designation	Value	Unit
Measuring time	20 to 600	s
Leak tightness limit (Unit selectable: µg/min, mm ³ /min, µl/min)	10 to 999	µg/min

Designation	Value	Unit
Measurement resolution	0.01	µm

Ambient conditions

Designation	Value	Unit
Temperature	15 to 35	°C
Relative humidity (non-condensing)	Max. 80	%

Emissions

Designation	Value	Unit
Noise emissions	< 75	dB(A)
Noise emission with "Quiet pressure release" See Quiet pressure release [Page 80].	< 68	dB(A)

EG-Konformitätserklärung
Déclaration de conformité CE
Declaration of conformity



DE FR EN

Wir **Witschi Electronic AG**
nous / We: **Bahnhofstrasse 26**
CH-3294 Büren a.A.
Schweiz / Suisse / Switzerland

erklären in alleiniger Verantwortung, dass das Produkt
déclarons sous notre seule responsabilité que le produit
declare under our sole responsibility that the product

Bezeichnung **ProofMaster**
nom / name:

Typ-Nr.: **31.2410**

Fabrikations-Nr. **1 – 5000**
no. de série / serial Nr.:

Funktion **Dichtigkeitsprüfgerät für Uhren**
fonction / function *Testeur d'étanchéité pour montres / Tightness tester for watches*

Dok-Verwaltung **Witschi Electronic AG, Roman Siegfried, Bahnhofstr. 26, CH-3294 Büren a.A.**
doc. management

Zertifiziertes QMS **SQS, ISO 9001:2015, Scope 19 / Reg. Nr. 12228**
Systèmes de QMS
Quality mgt, systems

auf das sich diese Erklärung bezieht, mit den Bestimmungen der folgenden EG-Richtlinie(n) und Norm(en) oder normativen Dokument(en) übereinstimmt:

auquel se réfère cette déclaration, est conforme aux dispositions de la (des) directive(s) CE et à la (aux) norme(s) ou autre(s) document(s) normatif(s) suivants:

to which this declaration applies, is in conformity with the following EC-Directive(s) and standard(s) or other normative document(s):

Richtlinien / Lignes directrices / Guidelines

- 2014/30/EG Elektromagnetische Verträglichkeit / *compatibilité électromagnétique* / electromagnetic compatibility
2014/35/EU Niederspannungsrichtlinie / *Directive CE pour basse tension* / EC low voltage directive
2006/42/EG Maschinenrichtlinie / *Directive CE pour machines* / EX machinery directive
2011/65/EU RoHS-Richtlinien / *Directives RoHS* / RoHS Directive

Fachgrundnormen / Normes génériques / Generic Standards

- EN 61000-6-3: 2007 Elektromagnetische Verträglichkeit (EMV), Störaussendung für Wohn- Geschäfts und Gewerbebereiche sowie Kleinbetriebe / *Compatibilité électromagnétique (CEM), Norme sur l'émission pour les environnements résidentiels, commerciaux et de l'industrie légère* / Electromagnetic compatibility (EMC), Emission standard for residential, commercial and light-industrial environments
EN 61000-6-4: 2011 Elektromagnetische Verträglichkeit (EMV), Störaussendung für Industriebereiche / *Compatibilité électromagnétique (CEM), Norme sur l'émission pour les environnements industriels* / Electromagnetic compatibility (EMC), Emission standard for industrial environments
EN 61000-6-1: 2016 Elektromagnetische Verträglichkeit (EMV), Störfestigkeit für Wohn- Geschäfts und Gewerbebereiche sowie Kleinbetriebe / *Compatibilité électromagnétique (CEM), Immunité pour les environnements résidentiels, commerciaux et de l'industrie légère* / Electromagnetic compatibility (EMC), Immunity for residential, commercial and light-industrial environments
EN 61000-6-2: 2016 Elektromagnetische Verträglichkeit (EMV), Störfestigkeit für Industriebereiche / *Compatibilité électromagnétique (CEM), Immunité pour les environnements industriels* / Electromagnetic compatibility (EMC), Immunity for industrial environments
EN ISO 12100-2010 Sicherheit von Maschinen / *Sécurité des Machines* / Safety of machinery

Büren a.A., den 13.7.2019

Daniel Hug
Leiter Entwicklung

Roman Siegfried
Leiter Produktions-Management

Declaration of conformity
Dichiarazione di conformità CE
Declaración de conformidad



EN IT ES

We **Witschi Electronic AG**
La / Nosotros: **Bahnhofstrasse 26**
CH-3294 Büren a.A.
Switzerland / Svizzera / Suiza

declare under our sole responsibility that the product
dichiara sotto la sua esclusiva responsabilità che il prodotto
declaramos por responsabilidad propia, que el producto

Name **ProofMaster**
nome / denominación:

Typ-Nr. **31.2410**
N. tipo / N° de tipo:

Serial-Nr. **1 – 5000**
N. di serie / N° de fabricación

Function **Tightness tester for watches**
funzione / función: *Tester di perdite per orologi / Comprobador de fugas para relojes*

doc. management **Witschi Electronic AG, Roman Siegfried, Bahnhofstr. 26, CH-3294 Büren a.A.**
Gestione doc./ Administración de documentos

Quality mgt, systems **SQS, ISO 9001:2015, Scope 19 / Reg. Nr. 12228**
QMS certificate / Sistema de gestión de calidad

to which this declaration applies, is in conformity with the following EC-Directive(s) and standard(s) or other normative document(s):

a cui si riferisce la presente dichiarazione è conforme ai requisiti previsti dalle direttive CE ed alle norme o ai documenti normativi elencati qui di seguito:

al cual hace referencia esta declaración, satisface las disposiciones de la(s) siguiente(s) directiva(s) UE y norma(s) o documento(s) normativo(s):

Guidelines

2014/30/EG Electromagnetic compatibility
2014/35/EU EC low voltage directive
2006/42/EG EX machinery directive
2011/65/EU RoHS Directive

Generic Standards

EN 61000-6-3: 2007 Electromagnetic compatibility (EMC), Emission standard for residential, commercial and light-industrial environments
+A1:2011+AC:2012
EN 61000-6-4: 2011 Electromagnetic compatibility (EMC), Emission standard for industrial environments
EN 61000-6-1: 2016 Electromagnetic compatibility (EMC), Immunity for residential, commercial and light-industrial environments
EN 61000-6-2: 2016 Electromagnetic compatibility (EMC), Immunity for industrial environments
EN ISO 12100-2010 Safety of machinery

Büren a.A., den 13.7.2019

Daniel Hug
Leiter Entwicklung

Roman Siegfried
Leiter Produktions-Management



🇨🇭 LEADING SWISS PRODUCTS



Witschi Electronic AG
Bahnhofstrasse 26
3294 Büren an der Aare
Switzerland
+41 32 352 05 00
www.witschi.com